

KENWOOD

CD PLAYER

DP-J2070

INSTRUCTION MANUAL

KENWOOD CORPORATION

This unit is designed for home use only.

If the unit is used in a location other than at home, such as in a shop (for commercial use), in a car or in a ship, etc., and is damaged, a service fee may be charged even during the warranty period.

For your records

Record the serial number, found on the back of the unit, in the spaces designated on the warranty card, and in the space provided below. Refer to the model and serial numbers whenever you call upon your dealer for information or service on this product.

Model _____ Serial Number _____

Unpacking

Unpack the unit carefully and make sure that all accessories are put aside so they will not be lost. Examine the unit for any possibility of shipping damage. If your unit is damaged or fails to operate, notify your dealer immediately. If your unit was shipped to you directly, notify the shipping company without delay. Only the consignee (the person or company receiving the unit) can file a claim against the carrier for shipping damage.

We recommend that you retain the original carton and packing materials for use should you transport or ship the unit in the future.

Accessories

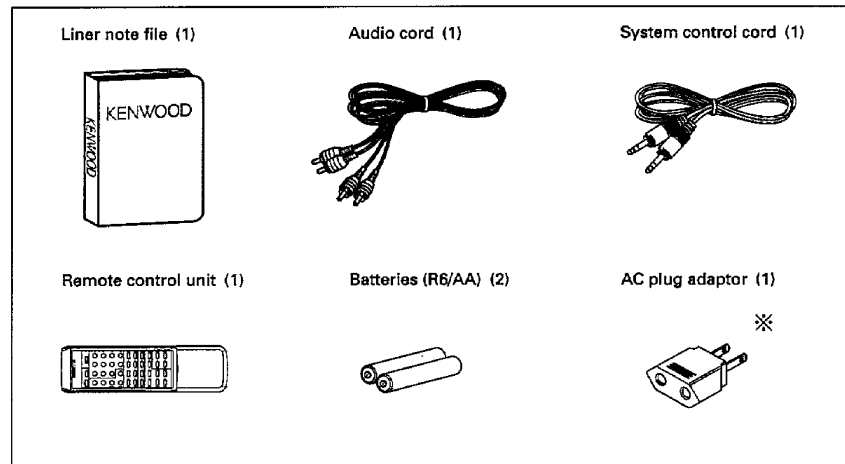

※ Use to adapt the plug on the power cord to the shape of the wall outlet. (Accessory only for regions where use is necessary.)

For Europe and U.K.

CE NOTICE

This (these) equipment(s) is (are) in conformity with the provision of EMC Directive, 89/336/EEC, 92/31/EEC and 93/68/EEC.

COMPACT
disc
DIGITAL AUDIO

B60-1995-10 (JA) (K,P,M,X,Y,T) G
96/12 11 10 9 8 7 6 5 4 3 2 1 95/12 11 10 9 8 7 6

Before applying power

Caution: Read this page carefully to ensure safe operation.

DP-J2070 (En)

Units are designed for operation as follows.

U.S.A. and Canada AC 120 V only
Australia AC 240 V only

Europe and U.K. AC 230 V only
***Other countries** AC110-120/220-240 V switchable

For the United Kingdom

Factory fitted moulded mains plug

1. The mains plug contains a fuse. For replacement, use only a 13-Amp ASTA-approved (BS1362) fuse.
2. The fuse cover must be refitted when replacing the fuse in the moulded plug.
3. Do not cut off the mains plug from this equipment. If the plug fitted is not suitable for the power points in your home or the cable is too short to reach a power point, then obtain an appropriate safety approved extension lead or adapter, or consult your dealer. If nonetheless the mains plug is cut off, remove the fuse and dispose of the plug immediately, to avoid a possible shock hazard by inadvertent connection to the mains supply.

IMPORTANT: The wires in the mains lead are coloured in accordance with the following code:

Blue : Neutral
 Brown : Live

Do not connect those leads to the earth terminal of a three-pin plug.

* AC voltage selection

The AC voltage selector switch on the rear panel is set to the voltage that prevails in the area to which the unit is shipped. Before connecting the power cord to your AC outlet, make sure that the setting position of this switch matches your line voltage. If not, it must be set to your voltage in accordance with the following direction.

AC voltage selector switch

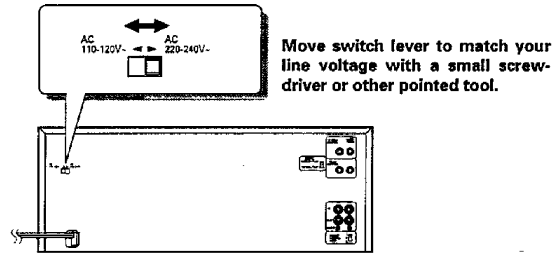

Note:
 Our warranty does not cover damage caused by excessive line voltage due to improper setting of the AC voltage selector switch.

Safety precautions

WARNING: TO PREVENT FIRE OR ELECTRIC SHOCK, DO NOT EXPOSE THIS APPLIANCE TO RAIN OR MOISTURE.

| | | |
|--|--|--|
| | <p>CAUTION RISK OF ELECTRIC SHOCK DO NOT OPEN</p> | <p>CAUTION: TO REDUCE THE RISK OF ELECTRIC SHOCK, DO NOT REMOVE COVER (OR BACK). NO USER-SERVICEABLE PARTS INSIDE, REFER SERVICING TO QUALIFIED SERVICE PERSONNEL.</p> |
| | <p>THE LIGHTNING FLASH WITH ARROWHEAD SYMBOL, WITHIN AN EQUILATERAL TRIANGLE, IS INTENDED TO ALERT THE USER TO THE PRESENCE OF UNINSULATED "DANGEROUS VOLTAGE" WITHIN THE PRODUCT'S ENCLOSURE THAT MAY BE OF SUFFICIENT MAGNITUDE TO CONSTITUTE A RISK OF ELECTRIC SHOCK TO PERSONS.</p> | |
| | <p>THE EXCLAMATION POINT WITHIN AN EQUILATERAL TRIANGLE IS INTENDED TO ALERT THE USER TO THE PRESENCE OF IMPORTANT OPERATING AND MAINTENANCE (SERVICING) INSTRUCTIONS IN THE LITERATURE ACCOMPANYING THE APPLIANCE.</p> | |

The marking of products using lasers (Except for some areas.)

**CLASS 1
 LASER PRODUCT**

The label is attached to the rear panel and says that the component uses laser beams that have been classified as Class 1. It means that the unit is utilizing laser beams that are of a weaker class. There is no danger of hazardous radiation outside the unit.

Before operation

DP-J2070 (En)

Removing the transport screws

Before using the unit, remove the 5 red transport screws (long x 2, medium x 2, short x 1) on the rear panel.

The screws can be removed by rotating in the directions of the arrows. After removing, be sure to retain the screws in a plastic bag, etc. They will be required the next time the unit is transported.

Before transporting the unit again, remove all discs from the rack, switch the power OFF and attach screws to their respective transport fixing holes.



This unit incorporates precision mechanisms. Avoid applying shock to the unit after the transport screws have been removed. Shock may cause malfunction of the mechanisms.

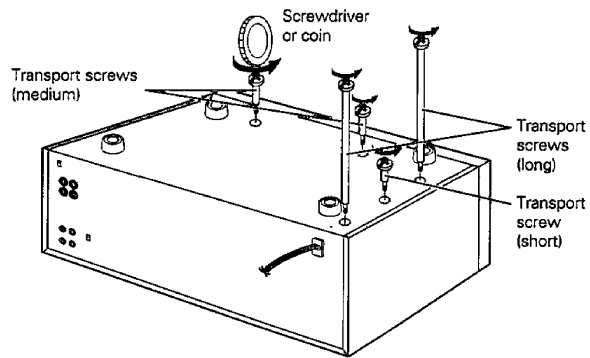

Types of discs playable on this unit

- With CDV, the time information and track number indicators are displayed only for the audio part.
- An 8 cm CD cannot be played back.

| Disc Type | Disc Size |
|-----------------------------------|-----------|
| CD (ordinary Compact Disc) | 12 cm |
| Audio part of CDV (CD with video) | 12 cm |

Beware of condensation

When water vapor comes into contact with the surface of cold material, water drops are produced.

If condensation occurs, correct operation may not be possible, or the unit may not function correctly.

This is not a malfunction, however, and the unit should be dried. (To do this, turn the POWER switch ON and leave the unit as it is for several hours.)

Be especially careful in the following conditions:

- When the unit is brought from a cold place to warm place, and there is a large temperature difference.
- When a heater starts operating.
- When the unit is brought from an air-conditioned place to a place of high temperature with high humidity.
- When there is a large difference between the internal temperature of the unit and the ambient temperature, or in conditions where condensation occurs easily.

Liner note file

The liner note file provided as accessory is convenient for storing the liner notes or jackets of the CDs loaded in this unit. Finding the desired disc will be easy if the liner notes are filed here in order of the disc numbers when loading CDs in this unit.

System connections

DP-J2070 (En)

Make connections as shown below.
When connecting the related system components, refer also to the instruction manuals of the related components.
Do not plug in the power lead until all connections are completed.

Be sure to use this unit placed on a level surface.



Malfunction of microcomputer

If operation is not possible or erroneous display appears even though all connections have been made properly, reset the microcomputer referring to "In case of difficulty".

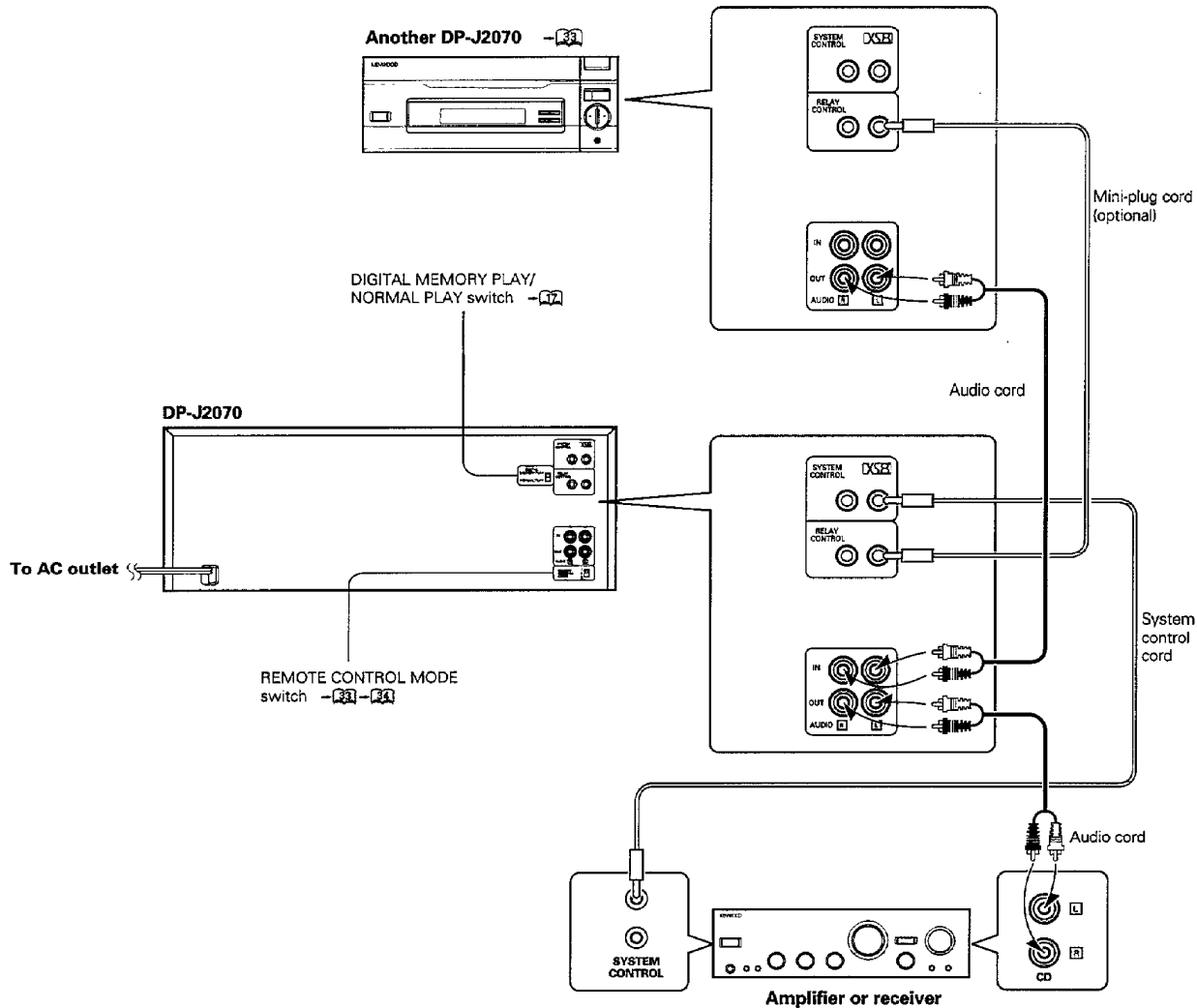

1. Connect all cords firmly. If connections are loose, there could be loss of sound or noise produced.
2. When plugging and unplugging connection cords, be sure to first remove the power cord from the AC outlet. Plugging/unplugging connection cords without removal of the power cord can cause malfunctions or damage to the unit.



System control connection

When connected to an amplifier or receiver having KENWOOD SYSTEM CONTROL terminals, system operation such as remote control is made possible. For details, refer to the instruction manual of the amplifier or receiver.

If your amplifier or receiver is not equipped with the SYSTEM CONTROL terminals, do not connect anything to any SYSTEM CONTROL terminals. Do not connect the unit in any system configuration other than specified.

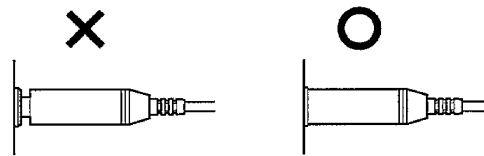

- Be sure to insert the system control cord plugs fully into the SYSTEM CONTROL terminals.
- If the system control cord and audio cords are not connected properly, the automatic system governing remote control and system functions will not operate.

Relay playback connection

When the RELAY CONTROL jack of this unit is connected with KENWOOD CD player(s) equipped with the relay control or system control jacks using mini-plug cord(s) (optional), the discs in two or three CD players can be played in relay playback (long-hour, continuous playback). For the connection for relay playback and the position of the REMOTE CONTROL MODE switch, read description in "Relay playback".

CCRS

By connecting the SYSTEM CONTROL terminal of this unit with the "XS" or "XSBI" SYSTEM CONTROL terminal of a KENWOOD cassette deck, CCRS recording can be carried out.

The CCRS function is used when recording from a CD to a tape in cassette deck, and operates to adjust the cassette deck's recording level to the optimum setting according to the playing level of the CD.

For details on the CCRS function, refer to the instruction manual provided with your cassette deck.

STANDBY mode of POWER switch

When the power cord of this system is plugged into an AC outlet, the STANDBY indicator lights up regardless of the ON/OFF setting of the POWER switch. This indicates that a small amount of current is being supplied to the unit to back up the memory contents. This mode is referred to as the StandBy mode. While the STANDBY indicator is lit, the power of the system can be switched ON/OFF from the remote control unit.

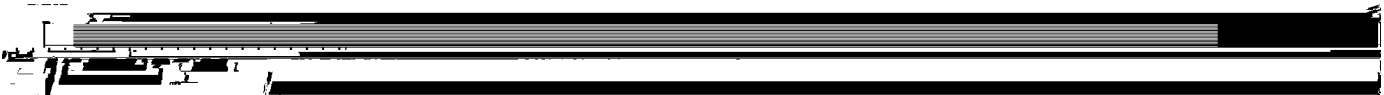

Controls and indicators

DP-J2070 (En)

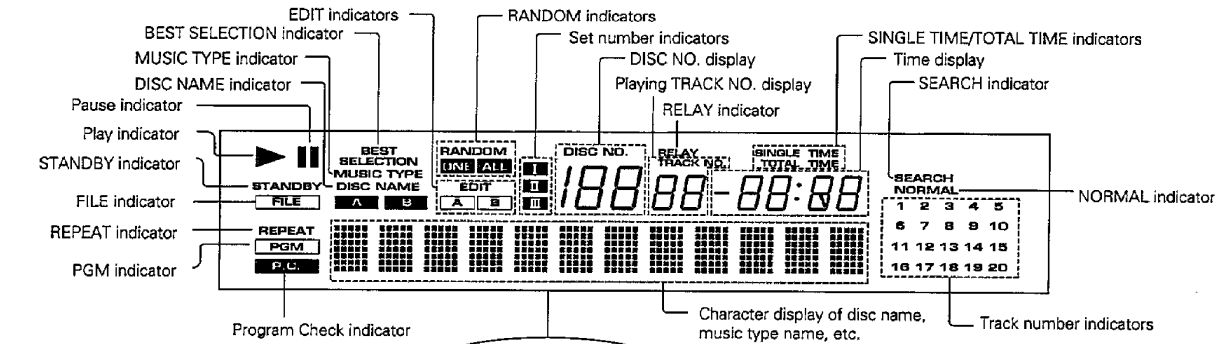

The marks are for your reference only.

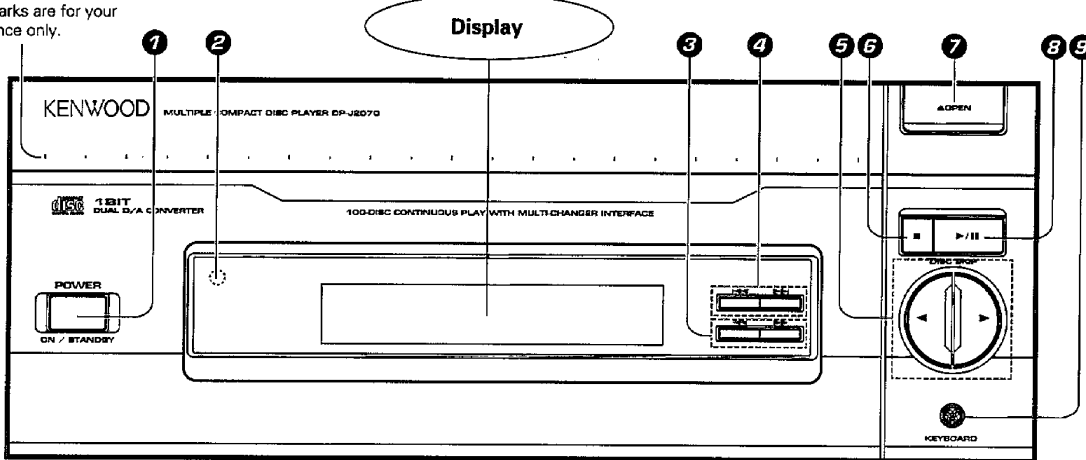

When the door panel is opened

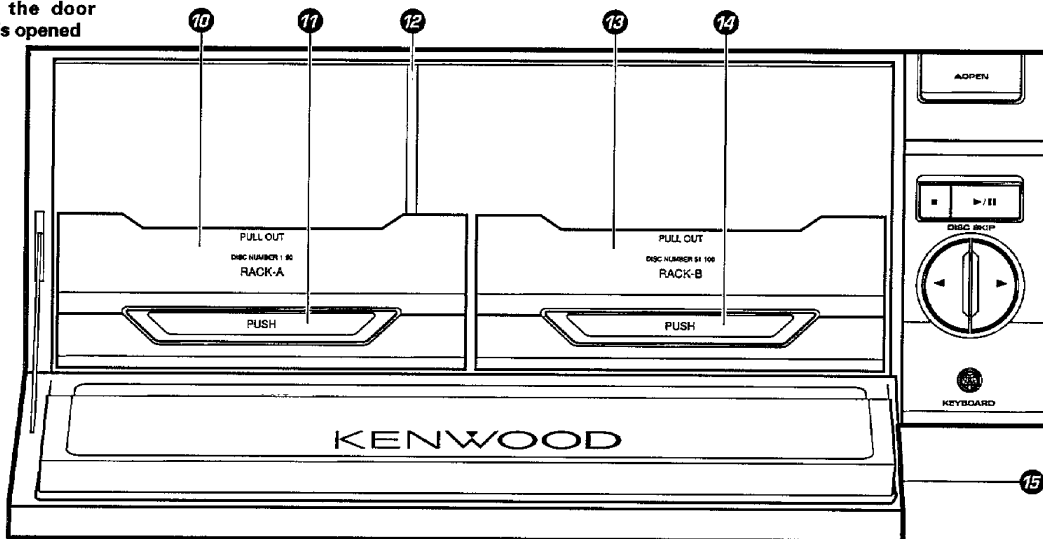

- ① **POWER key** - 12
- ② **Remote sensor** - 12
- ③ **Search keys (◀▶▶▶)** - 15
Press to move the played position of disc at high speed.
- ④ **Skip keys (◀▶▶▶)** - 15
Press to skip to the beginning of another track.
- ⑤ **DISC SKIP key** - 12
Press to select discs.
- ⑥ **Stop key (■)** - 12
- ⑦ **OPEN (▲) key** - 10
Press to open the door panel.
- ⑧ **Play/pause key (▶/||)** - 12

- ⑨ **KEYBOARD connector** - 25
For use in character input operation, an IBM-compatible PC keyboard can be connected here.
- ⑩ **Disc RACK A** - 10
- ⑪ **Disc RACK A lock button** - 10
Push and hold to slide out disc rack A.
- ⑫ **Selected disc indicator** - 10
The LED corresponding to the current selected disc lights.
- ⑬ **Disc RACK B** - 10
- ⑭ **Disc RACK B lock button** - 10
Push and hold to slide out disc rack B.
- ⑮ **Door panel** - 10

Remote control unit

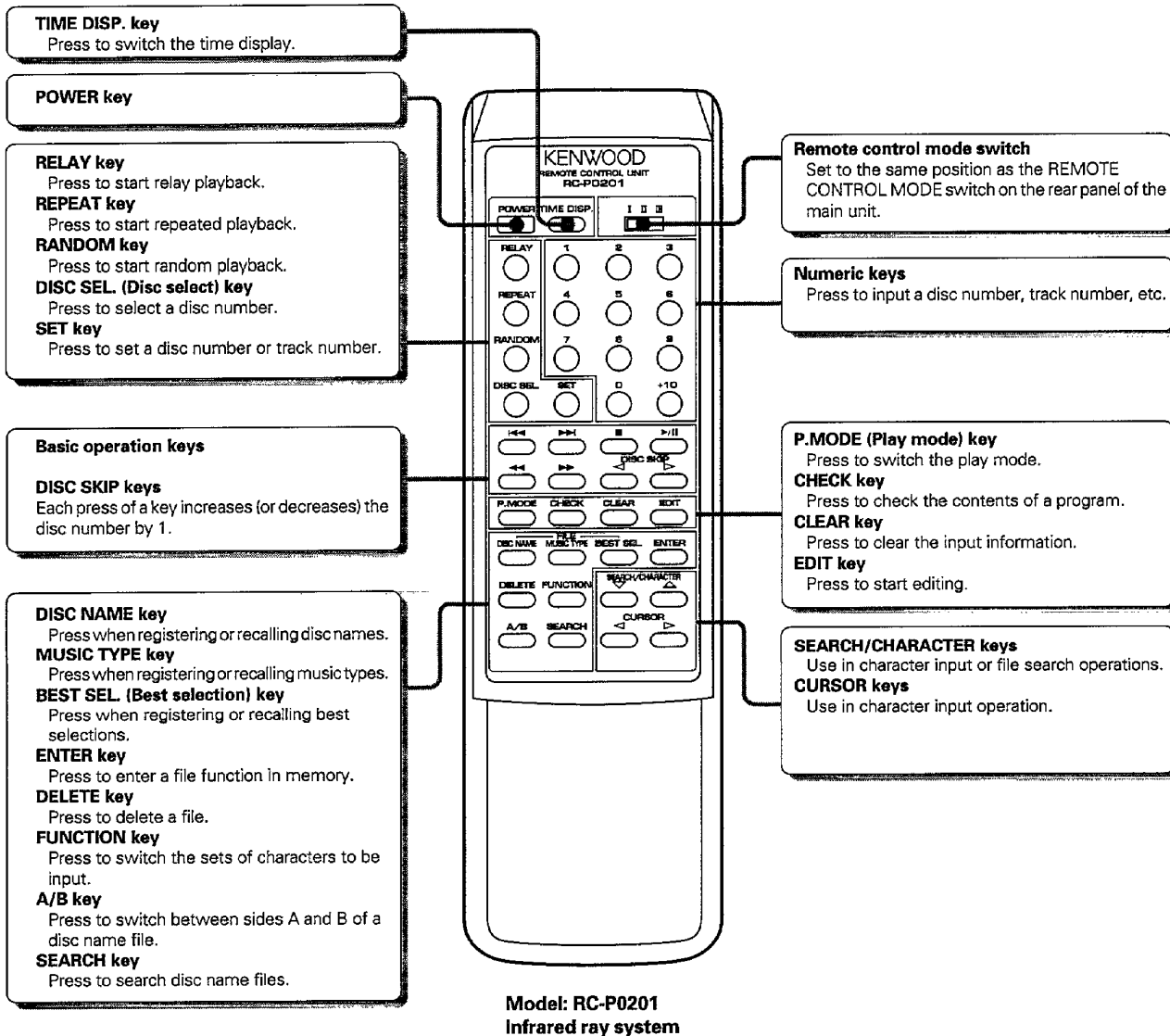

Loading batteries

1 Remove the cover.

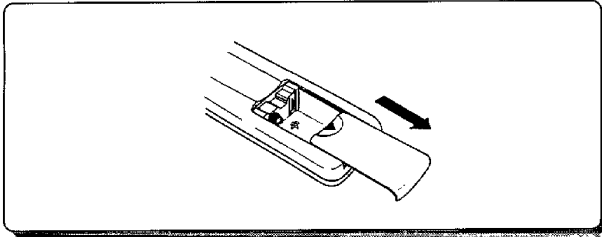

2 Insert batteries.

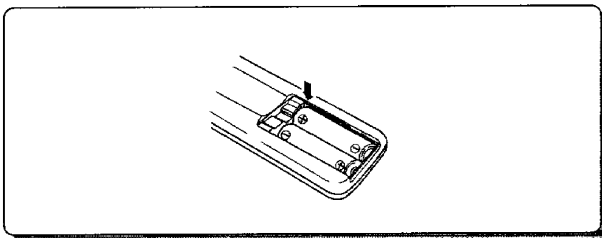

- Insert two R6 (AA-Size) batteries following the polarity indications.

3 Close the cover.

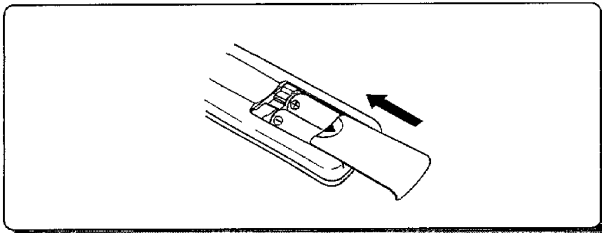

Operation

After plugging the power cord, press the **POWER** key of the remote control unit to turn the power of the system ON. When the power is turned ON, press the key of the function to be operated.

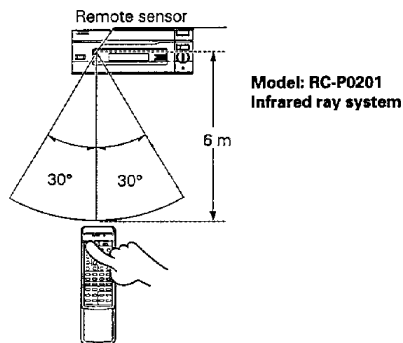

Operating range (approx.)

- When pressing more than one remote control keys successively, press the keys securely by leaving an interval of 1 second or more between keys.



1. The provided batteries are intended for use in operation checking, and their service life may be short.
2. When the remote controllable distance becomes short, replace both of the batteries with new ones.
3. If direct sunlight or the light of a high-frequency fluorescent lamp (inverter type, etc.) is incident to the remote sensor, malfunction may occur. In such a case, change the installation position to avoid malfunction.

Preparation

DP-J2070 (En)

Up to 100 CDs can be loaded in the disc racks. When loading CDs in the racks, it will be convenient for future reference of the liner notes or jackets are filed in the liner note file in the same order as the order followed in loading the CDs.

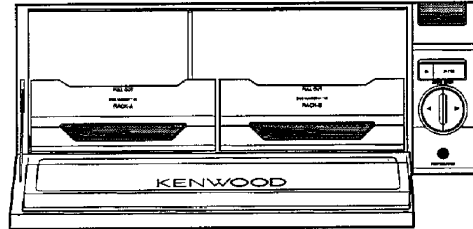

■ : Indicates the keys, etc., to be used.

Loading discs in disc racks

1 Open the door panel toward the front.

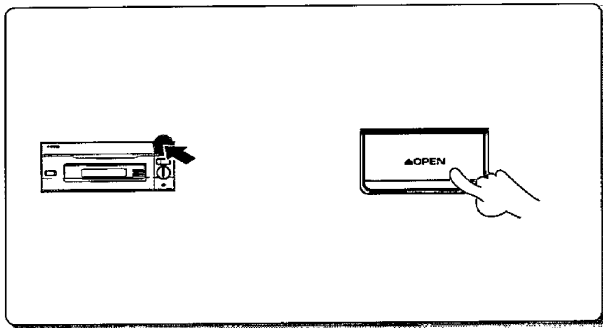

• Do not place any object on the open door panel.

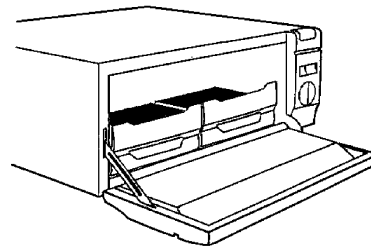

2 Slide out a rack.

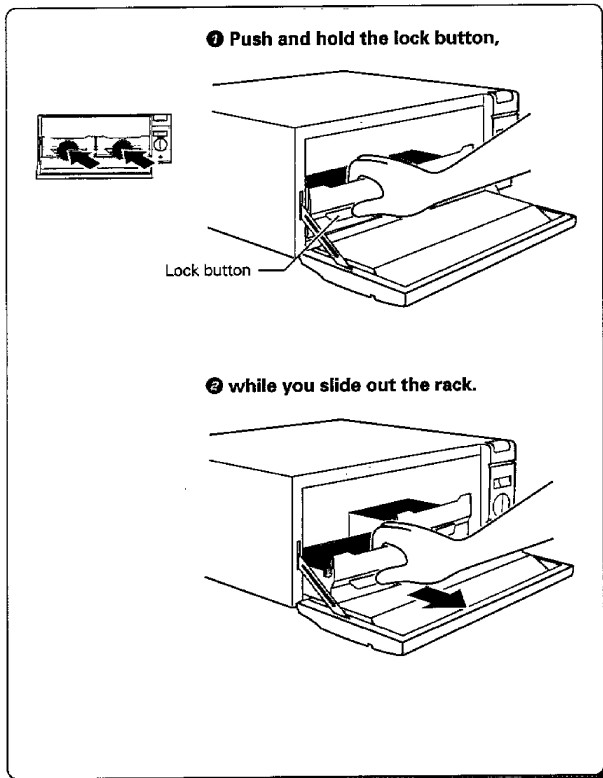

• Slide out the rack to load discs in.

• The rack including the disc being indicated by the selected disc indicator cannot be slid out. If it is required to slide out such a rack or both racks simultaneously, close the door panel, switch power OFF and open the door panel again.

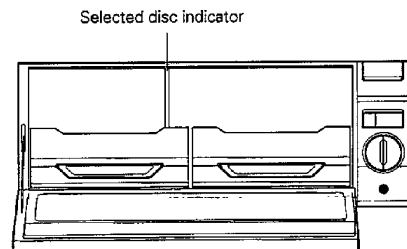

DP-J2070 (En)

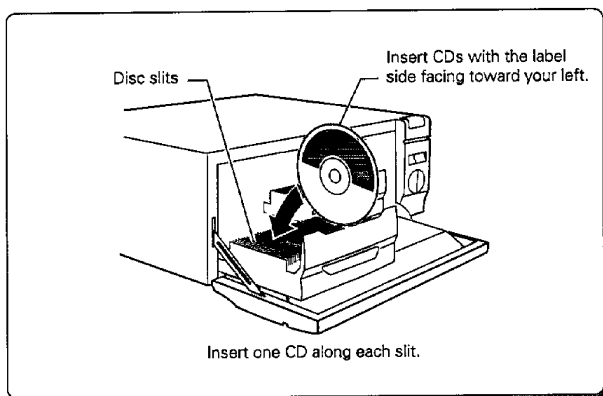
3 Load discs.

- Each of racks A and B can accommodate up to 50 discs.
- Do not insert more than one disc in a slit.

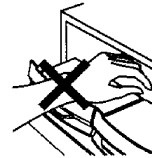
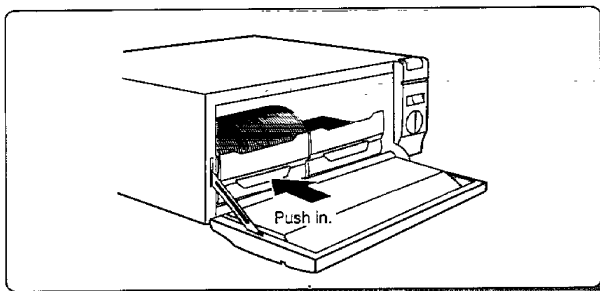

Never let your hand or any object enter inside the unit.

**4 Set the racks back to the original positions.**

- Push in the rack until it stops.
- To load discs in another rack, repeat steps 2 to 4 above.

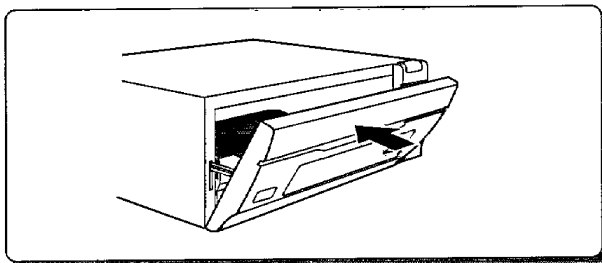
5 Close the door panel.**Disc replacement**

Discs can be replaced with the same procedure as "Loading discs in disc racks". If disc data has been registered following "Registration of disc name file", disc data can be recalled even when the location of the disc has been changed. → 24



Remove all discs from the racks before transporting this unit.

Operations for playback

DP-J2070 (En)

Preparation

- Load discs in the racks.

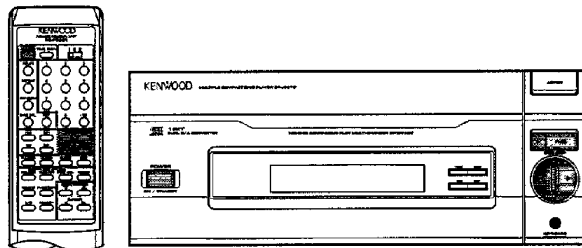

■ : Indicates the keys, etc., to be used.

Playing a desired disc in order from track No. 1

Use the following procedure to play CDs in the original order of tracks from track No. 1.

1 Switch power ON.

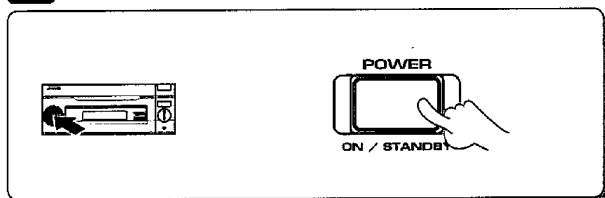

- If discs have been loaded in the unit, the last selected disc starts to play when the power is turned ON. Go to step 2 if you want to play another disc.



2 Select the disc.

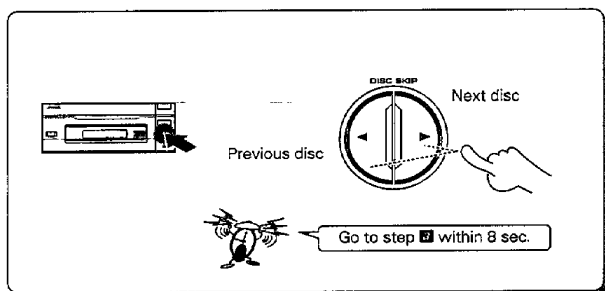

- Each press of a key increases (or decreases) the disc number. Holding the key depressed varies the disc numbers successively.

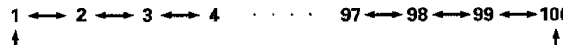

Display when disc No. 63 is selected



3 Start playback.

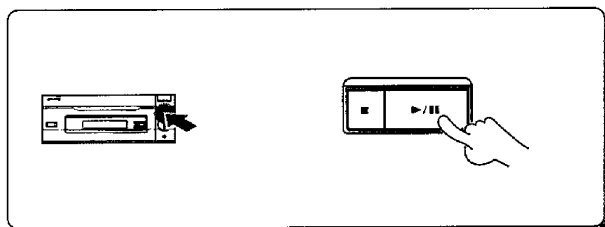

- If the ▶/|| key is pressed without selecting a disc, the currently selected disc will be played.
- If no disc has been loaded for the selected disc number, the next disc number is selected automatically.

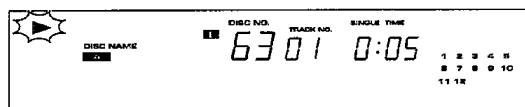

To pause playback

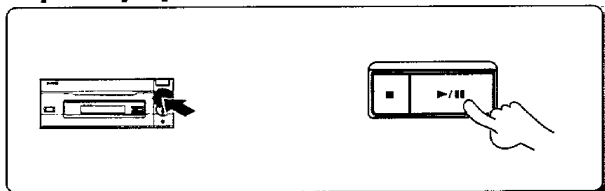

- Each press pauses and plays the CD alternately.

To stop playback

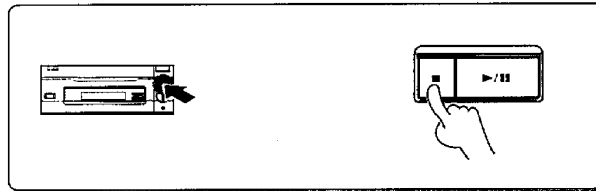

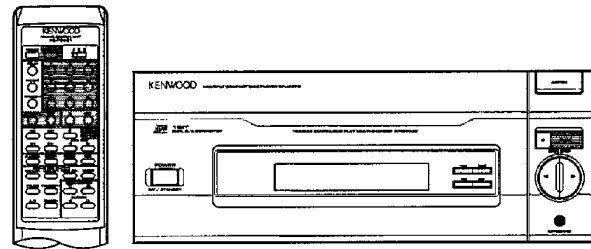

 : Indicates the keys, etc., to be used.

Direct disc selection



- 1 Press the DISC SEL. key.

DISC SEL.



Within 8 seconds!
- 2 Input the disc number.

| | | |
|---|-----|---|
| 1 | 2 | 3 |
| 4 | 5 | 6 |
| 7 | 8 | 9 |
| 0 | -10 | |



Within 8 seconds!
- 3 Set the input.





SET

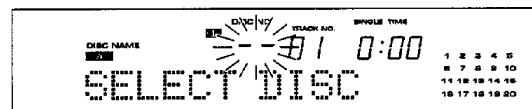

- 4 Start playback.



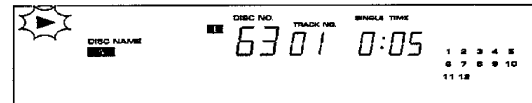
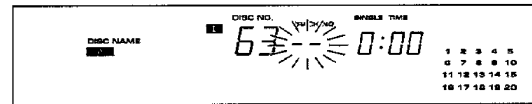

Press the numeric keys in the following order...

Disc No. 63 :  
 Disc No. 100 :   







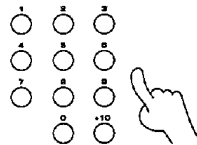

How to input numeric values









As this unit requires input of large numeric values, it adopts a different input method from other KENWOOD products. However, the method used with other KENWOOD products can also be used to input numeric values in this unit.



Special input method for CD player with 100-disc changer

To input 12 :  
 To input 45 :  
 To input 100 :   

Same input method as other KENWOOD products

To input 12 :  
 To input 45 :     
 To input 100 :  10 times

Playback from desired track

DP-J2070 (En)

Preparation • Load discs in the racks.

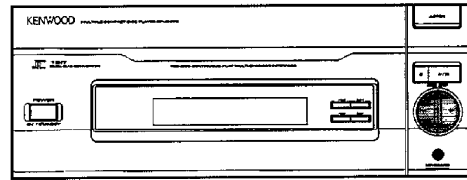
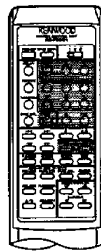

■ : Indicates the keys, etc., to be used.

1 Check that the "PGM" indicator is not lit.

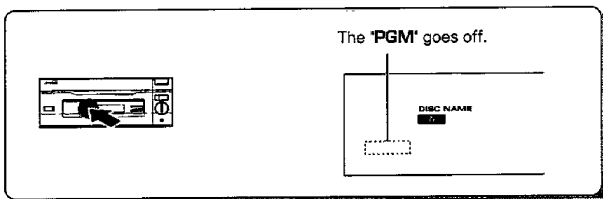

- If the "PGM" indicator is lit, press the **P.MODE** key of the remote control unit to turn it off.

2 Select the disc.

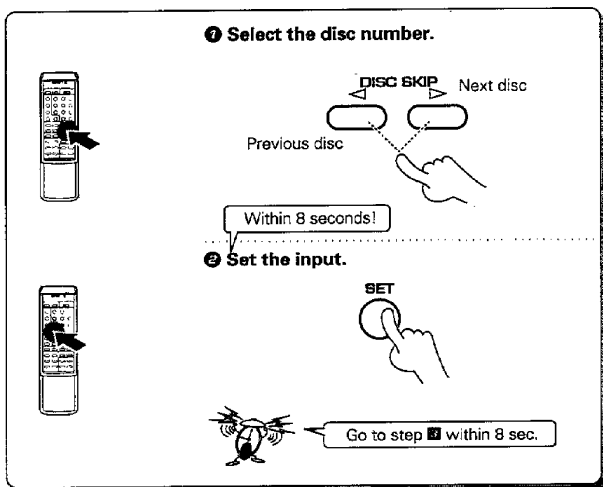

Display when disc No. 63 is selected

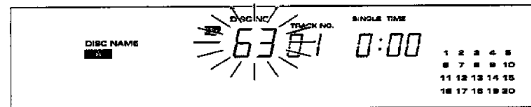

- The disc number can be selected directly by using the **DISC SEL.** and numeric keys in place of the **DISC SKIP** keys.

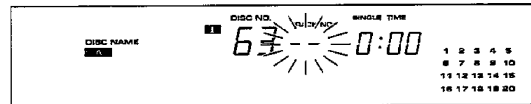

- Repeat step 2 when it is required to change the disc number.

3 Select the track number.

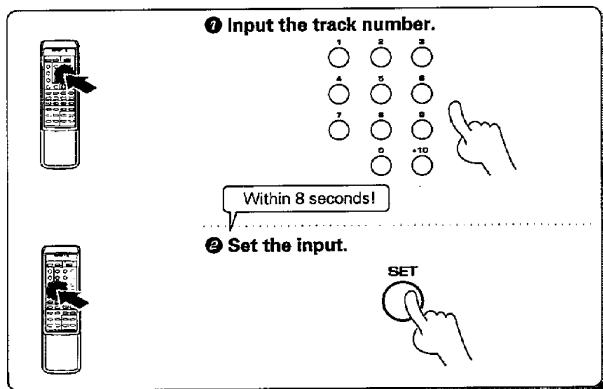

Press the numeric keys in the following order...

- Track No.8 : **8**
- Track No.14 : **1 4**
- Track No.20 : **2 0**

- Playback starts.

Display when track No. 8 is selected

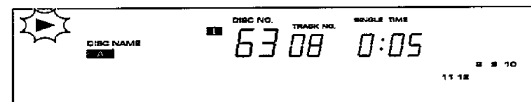

- Repeat step 3 when it is required to change the track number.

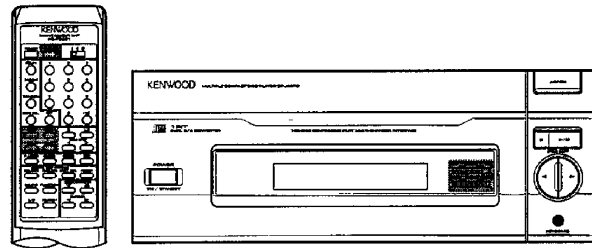

■ : Indicates the keys, etc., to be used.

Skipping tracks

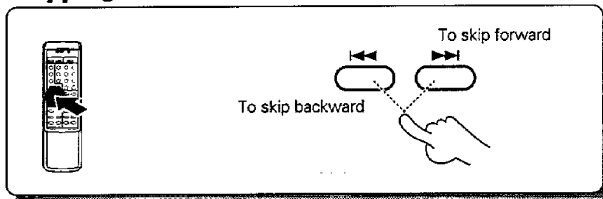

- When the \lll key is pressed once during playback, the track being played will be played from the beginning.

Searching

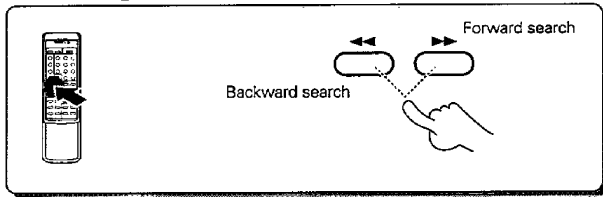

- Playback starts from the position where the key is released.

Time display

Each press of the TIME DISP. key changes the displayed contents.

- | | | |
|---|----------------------|--------------------------------------|
| ① | SHINGLE TIME 1:23 | Elapsed time of track being played. |
| ② | - 2:37 | Remaining time of track being played |
| ③ | TOTAL TIME 23:45 | Elapsed time of entire disc |
| ④ | TOTAL TIME -36:15 | Remaining time on entire disc |

- Only the SINGLE TIME information is available while the PGM, RANDOM, MUSIC TYPE or BEST SELECTION indicator is lit.
- While the EDIT indicator is lit in the edit mode, the display is used in the tape length setting operation.

Tip on the disc selection methods

Discs can be selected either in sequence using the DISC SKIP keys or directly using the DISC SEL. and numeric keys.
If there are a large number of discs and you do not remember the exact number of the target disc, first select a location which seems to be near the target disc by using the DISC SEL. and numeric keys, then search its neighbors using the DISC SKIP keys. This method will make it relatively easy to locate the desired disc.

Programming tracks in desired order

DP-J2070 (En)

Use the following procedure to select desired tracks (up to 32 tracks) from up to 100 discs and program them in the desired order.

Preparation

- Load discs in the racks.
- Set the CD player to stop mode.

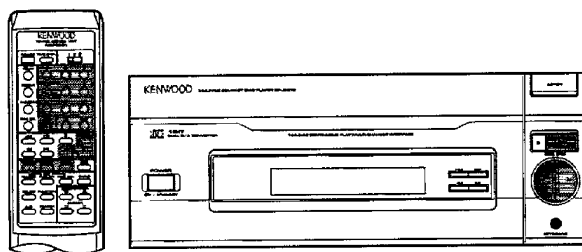

■ : Indicates the keys, etc., to be used.

1 Press so that the PGM indicator lights.

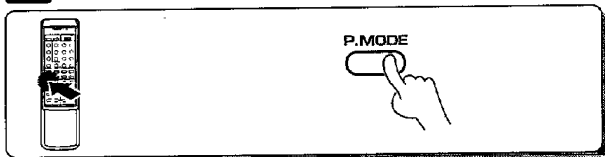

Only 'SINGLE TIME' is displayed in program mode.

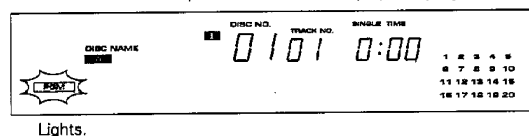

Lights.

2 Select the disc.

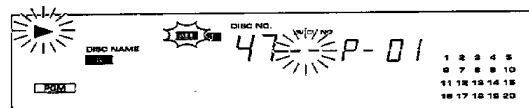
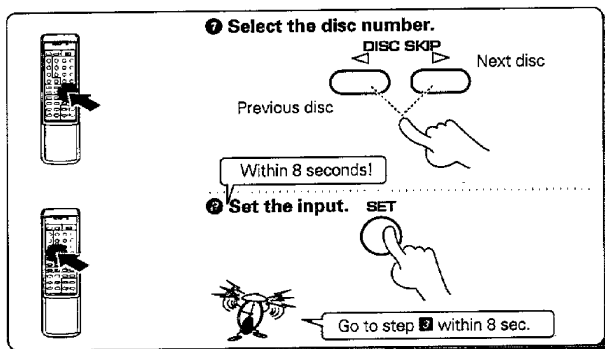

- The disc number can be selected directly by using the **DISC SEL.** and numeric keys in place of the **DISC SKIP** keys.

- If you make a mistake, press the **CLEAR** key and enter the track No. from the beginning.
- Disc numbers which do not contain discs can be selected, but they are canceled at the time of playback.

3 Select a track.

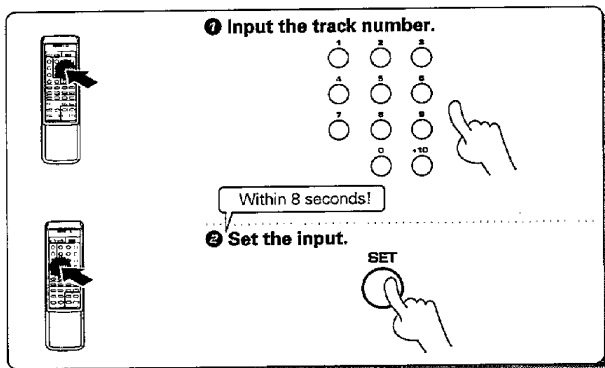

- To program the entire disc, press the **SET** key without inputting the track number.

Displays the entered track No.

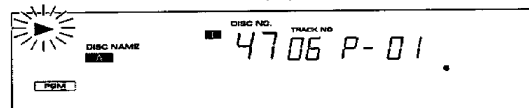

- Program other tracks in the desired order by repeating steps 2 and 3.
- Up to 32 tracks can be programmed. "FULL" is displayed when no more tracks can be programmed.
- If you make a mistake, press the **CLEAR** key and restart from step 2.

4 Start playback.

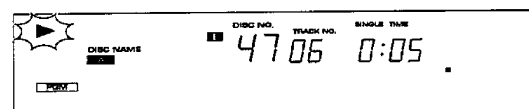
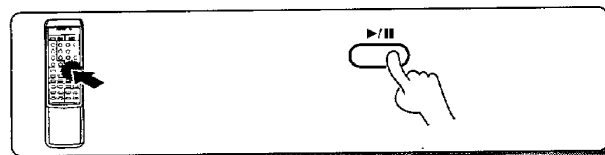

- Tracks will be played in the order they were programmed (in order of P Nos.).
- When the **◀◀** or **▶▶** key is pressed during playback, the track will be skipped in the direction of the pressed button.

Continuous playback

To reduce the disc change time during programmed playback or random play involving several discs, this unit incorporates a digital memory that rotates discs at double the normal speed and stores the music in a special digital memory circuit. Setting the DIGITAL MEMORY PLAY/NORMAL PLAY switch on the rear panel to the DIGITAL MEMORY PLAY position activates this feature.



- The display shown below appears when the data stored in the digital memory is played during disc change. In this condition, other keys than the **POWER** and **STOP** keys are invalid.

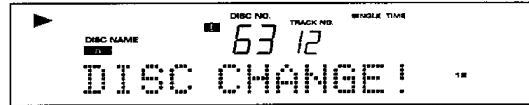

- Digital memory play does not occur during best selection playback and relay playback.

To check the programmed tracks

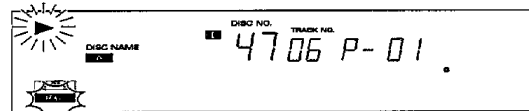
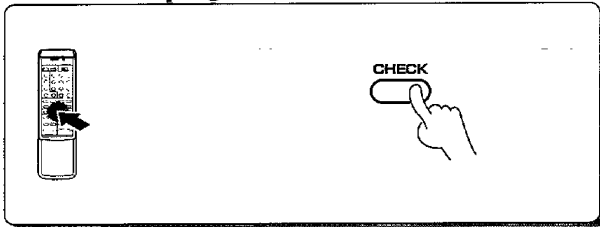

P.C. lights.

- Each time the key is pressed, the program No. (P-NO) and the disc No. are displayed.
- The previous display resumes in a few seconds.

To add a track to the program

- Set the CD player to stop mode.
- Perform steps ② and ③ of "Programming tracks in desired order". 

- When a track No. is entered, the track will be added to the end of the existing program.

To change a track in the program

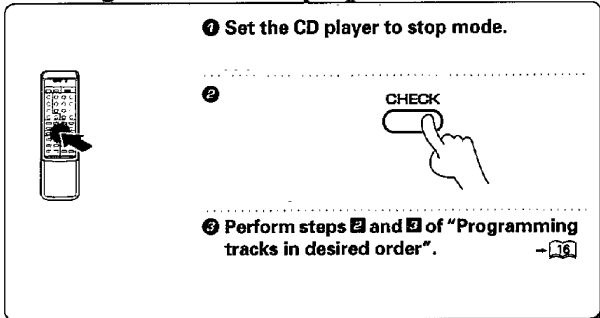

- Press the **CHECK** key repeatedly until the track No. to be changed is displayed.

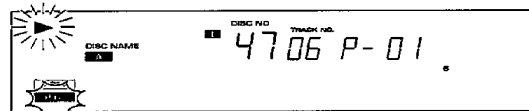

P.C. lights.

- Press while the "P.C." indicator is lit.

To clear track from the program

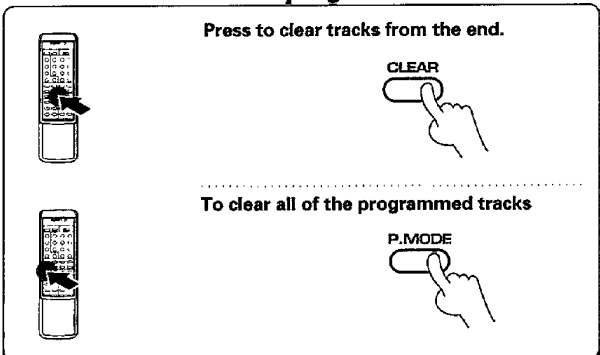

- Each time the key is pressed, the last track in the program is cleared.
- The track being played cannot be cleared.

- When the **P.MODE** key is pressed during playback, playback in order of tracks starts from the track being played.

Repeated playback

DP-J2070 (En)

Preparation

- Load discs in the racks.

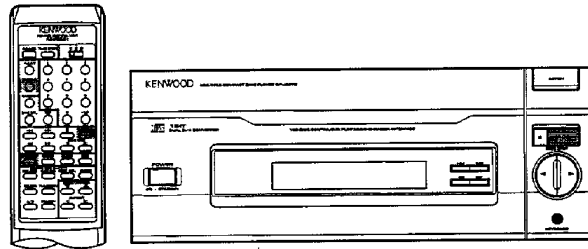

: Indicates the keys, etc., to be used.

To repeat only the desired tracks (discs)

- 1 Program the desired tracks (discs) by performing steps 1 to 3 of "Programming tracks in desired order".

- 2 Switch REPEAT ON.



- 3 Start playback.

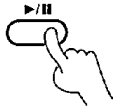

- Up to 32 tracks can be programmed by repeating steps 1.

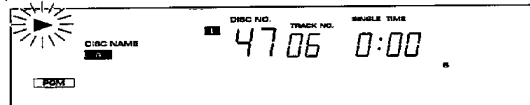

Press P.MODE key so that the "PGM" indicator lights.

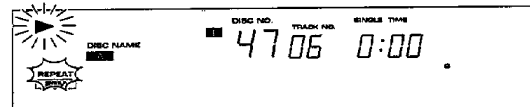

Press so that the "REPEAT" indicator lights.

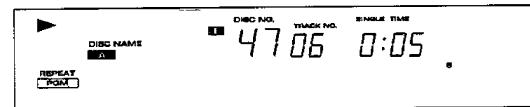

- All of the programmed tracks will be repeated.
- In case only one track is programmed, only that track will be repeated.

To stop repeated playback

Press the REPEAT key again.

To repeat all of the loaded discs

- 1 Press so that the "PGM" indicator goes off.

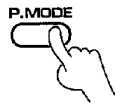

- 2 Switch REPEAT ON.

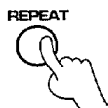

- 3 Start playback.



Press so that the "PGM" indicator goes off.

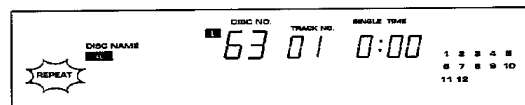
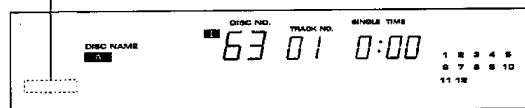

Press so that the "REPEAT" indicator lights.

- Starting with the currently selected disc, all discs in racks A and B are played repeatedly in order of disc numbers.

To stop repeated playback

Press the REPEAT key again.

Playback in a random order (Random playback)

DP-J2070 (En)

Use the following procedure to activate random playback which selects a track at random after every track. This feature may allow you to play CDs for long hours without getting tired of.

Preparation

- Load discs in the racks.

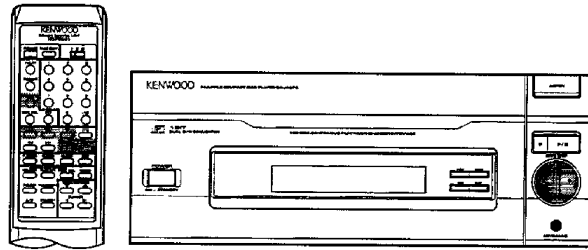

 : Indicates the keys, etc., to be used.

1 Check that the PGM indicator is not lit.

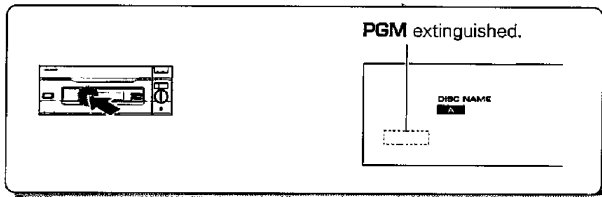

- If the "PGM" indicator is lit, press the **P.MODE** key of the remote control unit to turn it off.

2 Select discs.

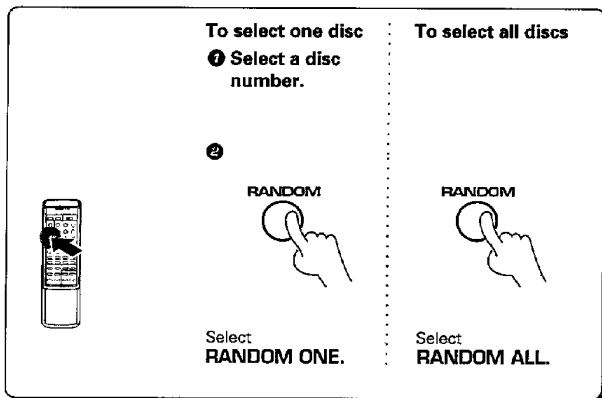

Each press of the **RANDOM** key changes the random playback modes.

- ① **RANDOM ONE**: Random playback from a single disc.
- ② **RANDOM ALL**: Random playback from all discs.
- ③ **OFF**: Random playback is OFF.

"RANDOM ONE/RANDOM ALL" indicators

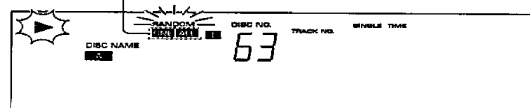

Display when track No. 3 of disc No. 74 is selected during **RANDOM ALL**.

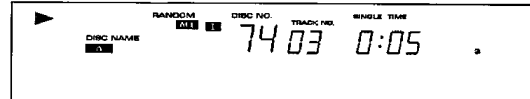

- Random playback starts by selecting tracks in a random order.

To select another track in the middle of playing one

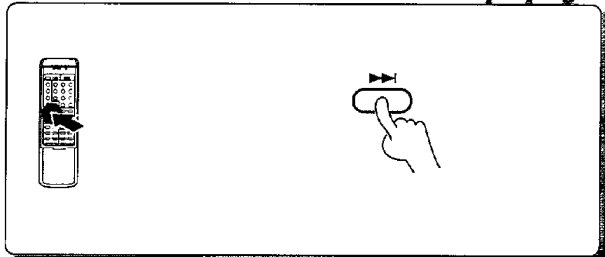

- Pressing the **1** key once returns to the beginning of the track being played.

To cancel random playback

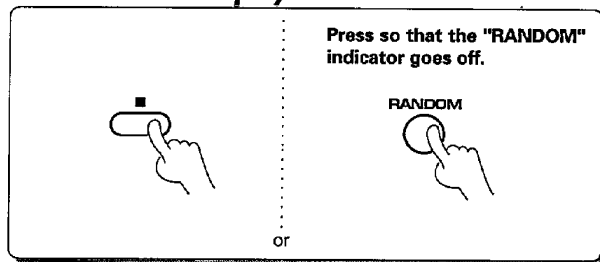

- Press the **■** key to stop playback.
- Press the **RANDOM** key to start normal playback.

This function is for editing when you are recording the contents of a CD onto a tape. It is to ensure that the final track on each side of the tape is fully recorded and that the possible recording time on the tape will be fully used.

Preparation

- Load discs in the racks.
- Set the CD player to stop mode.

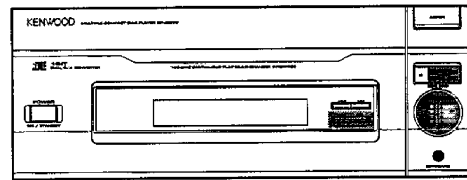
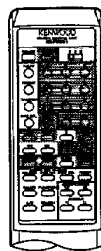

: Indicates the keys, etc., to be used.

1 Select the edit mode.

- 1 Check that the PGM indicator is not lit.
- 2 Press the EDIT key.

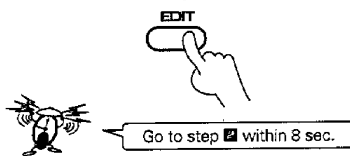

Go to step 2 within 8 sec.

- If the "PGM" indicator is lit, press the P.MODE key of the remote control unit to turn it off.

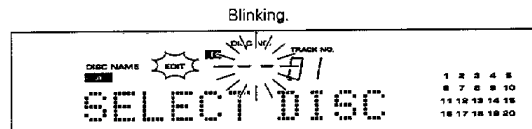

2 Select the disc to be edited.

- 1 Select a disc number.

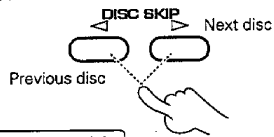

Within 8 seconds!

- 2 Set the input.

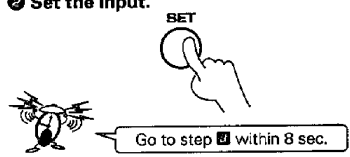

Go to step 3 within 8 sec.

- Each press of a key increases (or decreases) the disc number. Holding the key depressed varies the disc numbers successively.
- The disc number can be selected directly by using the numeric keys in place of the DISC SKIP keys.
- The edit function cannot be used for two or more discs.

3 Input the recording time of the tape.

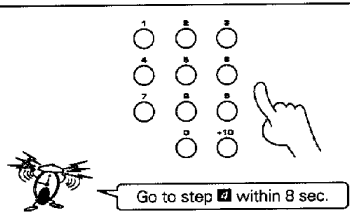

Go to step 4 within 8 sec.

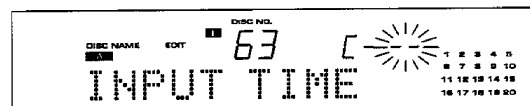

Press the numeric keys in the following order...

- 30-minute tape : **3 0**
 46-minute tape : **4 6**

- The 46-, 54-, 60- and 90-minute tape length can be selected easily by pressing the TIME DISP. key for the required number of times.

4 Start editing.

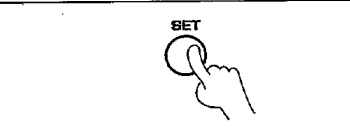

- Editing starts.
- After editing, press the P.MODE key to end the edit mode.
- Up to 32 tracks can be edited.

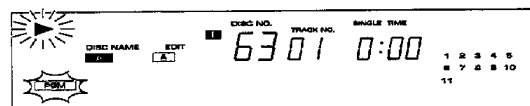

To record an edited program

The CCRS recording function may be used by connecting the CD player to any KENWOOD cassette deck with an "DXS" or "DXSB" mark, using a system control cord.
For details please refer to "Recording of CD playback" section in your cassette deck instruction manual.

The CD contents are edited as follows.

① The input tape recording time is divided by two, and tracks that can be accommodated in file A (which refers to tracks on tape side A) are selected in order of their track Nos.

② In a few seconds, the time left on tape side A is displayed, then file B (tracks on tape side B) is edited in the same manner.

- After editing, the "EDIT" indicator changes from blinking to steady lighting.

To check the edited contents

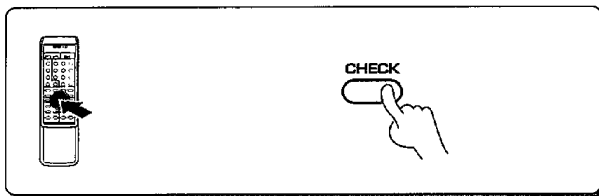

- The track numbers are displayed in the order they were edited.

To play an edited program

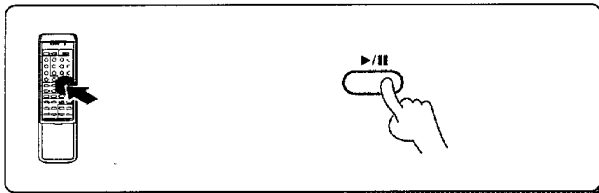

- The tracks in file side A are played in sequence, after which the player pauses at the beginning of file side B. Press the ▶/|| key again to start playing file side B tracks.

- Playback stops after having played the B file.

To clear the edited contents

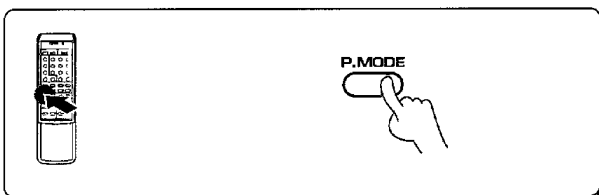

- All of the editing contents are cleared.



1. While you can edit with a different time setting to that of the tape you are using, part of the tape may be left with nothing recorded on it, or the last track on side A or side B may be cut short.
2. Up to a maximum of 32 tracks can be edited using this function.
3. The EDIT function may not operate properly for discs having only one track or having tracks of long duration such as classical music.

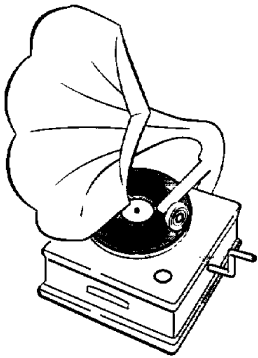

Creation of files

DP-J2070 (En)

With this unit, the loaded discs can be grouped in various types of files. Use the desired files as you like according to the discs.

Types of files

Disc name files

-(24)

The information on a disc such as the artist name and disc title can be registered in the disc name file of each disc. When a disc, which has been registered is selected, the display shows the registered disc's name. The disc names make it possible to search the desired disc easily from the large number of discs. As the disc names are registered together with the TOC (information on the number of tracks, playing time, etc.) originally recorded on the disc, the disc names can be recalled by playing the disc even after the disc loading location has been changed.

Disc name file side A



Disc name file side B

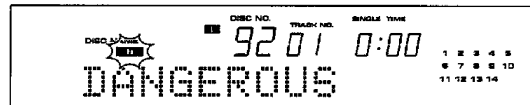

- In case more than one disc has the same TOC information such as the number of tracks and playing time, correct disc names may not be recalled. In such a case, register the disc names again.

Music type files

-(26)

Discs in the racks can be categorized according to the music genres and up to 32 discs can be registered in each of the music type files (JAZZ, POP, CLASSIC, ROCK, RHYTHM & BLUES, COUNTRY and EASY). In addition to these music type files, three user name files (USER 1 to 3) are available. The user can create desired music files from them and assign desired names.

By filing the discs according to the music types, it is possible to perform random playback of a specific music type.

(Refer to "Random playback within a music type". -(30))

Music type file

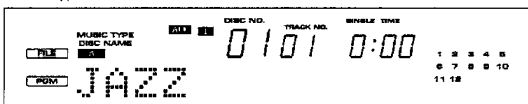

User name file



Best selection file

-(31)

Among the discs in the racks, only the favorite tracks can be selected and registered in the best selection file. When you want to play favorite tracks, all you have to do is initiate the best selection mode and start playback.

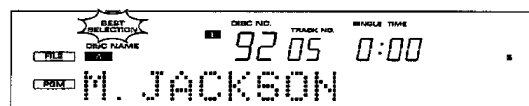

Registration (deletion) of disc name files

DP-J2070 (En)

Use the following procedure to assign disc names to each disc. Using up to 12 characters per name, two names can be registered in two sides (A, B) of each disc name file.

Preparation

- Load discs in the racks.
- Set the CD player to stop mode.
- Check that the 'PGM' indicator is not lit.

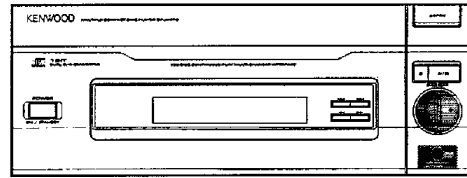
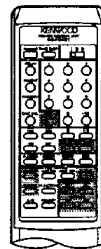

■ : Indicates the keys, etc., to be used.

1 Activate the disc name input mode.

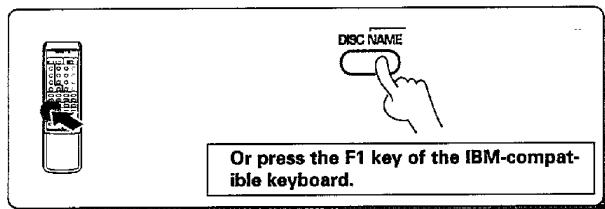

Or press the F1 key of the IBM-compatible keyboard.

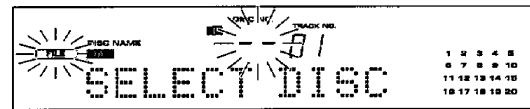

- If the **DISC NAME** key is pressed in the disc name input mode, the input mode is canceled.

2 Select the desired disc.

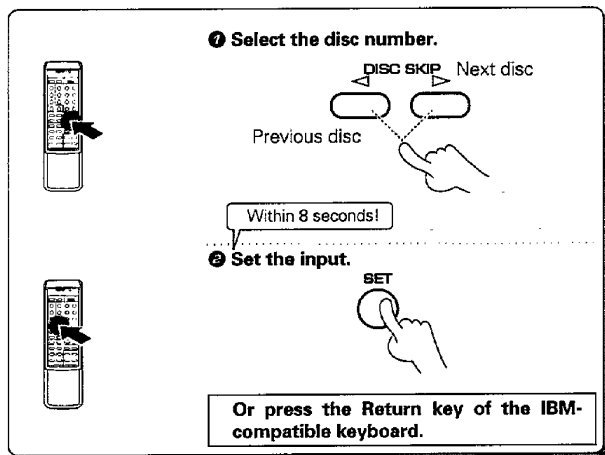

Or press the Return key of the IBM-compatible keyboard.

- The disc number can be selected directly by using the numeric keys in place of the **DISC SKIP** keys.

Numeric keys: The numeric keys of the IBM-compatible keyboard can also be used.

3 Input the disc name (for file side A).

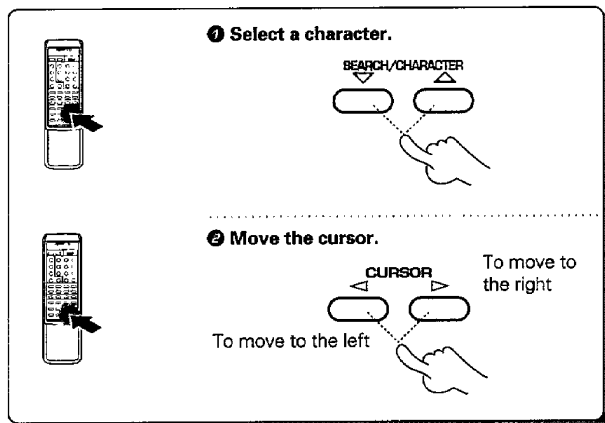

Or press the Return key of the IBM-compatible keyboard.

- Refer to "How to input characters".

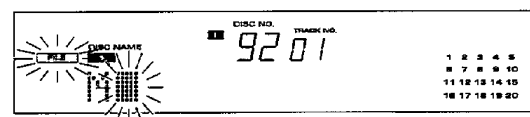
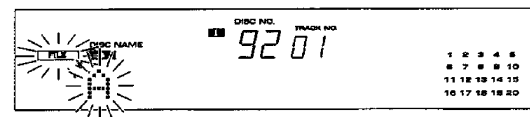

- Input the entire disc name by repeating ① and ② for each character.

How to input characters

① Each character can be input by combining the following keys. SEARCH/CHARACTER keys:

The sets of characters usable in registration are displayed in the order of ① to ④ shown on the right.

FUNCTION key:

Press to switch the character sets (① to ④). After selecting the character set, select a character with the SEARCH/CHARACTER keys.

CURSOR keys:

Press to select the column where the next character is to be input. The column being selected blinks.

- ① A B C...X Y Z
- ② a b c...x y z
- ③ 0 1 2 3...7 8 9 ! " # % & ' () * + , - . / : ; < = > ? [] ^ _ ` { | } ~
- ④ (1 space)

② Characters can also be input using an IBM-compatible PC keyboard. Connect an IBM-compatible keyboard to the KEYBOARD connector on the front panel and input characters. Basically, the characters which are displayed by pressing the SEARCH/CHARACTER keys can be input, but certain keyboards may not be able to input all of the usable characters. When inputting characters which need the Shift key, press the Shift key again after every character.

4 Enter the input disc name in memory.



Or press the Return key of the IBM-compatible keyboard.

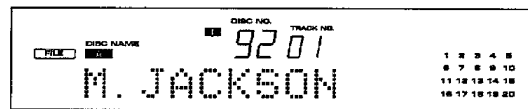

5 Input the disc name (for file side B).

Input the disc name with the same operation as step 4.

- ① Select a character.
- ② Move the cursor.

- Input the entire disc name by repeating ① and ② for each character.
- If the character input of file side B is not required, skip this step and proceed to step 6 after step 4.

6 Enter the input disc name in memory.

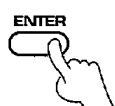

Or press the Return key of the IBM-compatible keyboard.

- To register the disc names of another disc, repeat the entire procedure from step 4 for it.



To delete the disc names

- ① Perform steps 4 and 5 of "Registration (deletion) of disc name files" to recall the disc name which is to be cleared. - (24)
- ② Press the DELETE key.
- ③ Press the ENTER key.

- The disc name is indicated on the display.

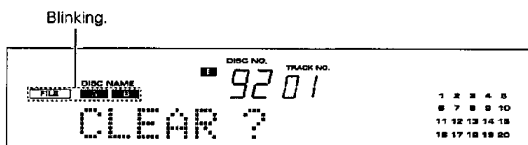

- Press the DISC NAME key to cancel the delete mode.

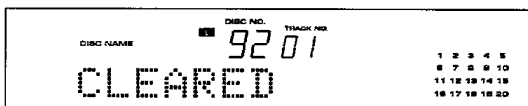

Searching disc name files

DP-J2070 (En)

Preparation

- Load discs in the racks.
- Register disc names.
- Check that the 'PGM' indicator is not lit.
- Set the CD player to stop mode.

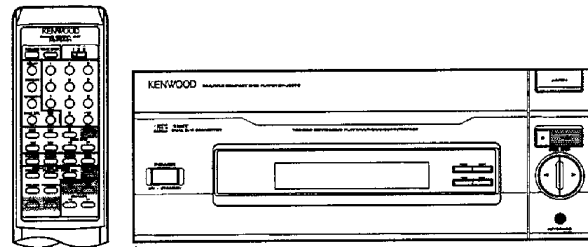

■ : Indicates the keys, etc., to be used.

1 Activate the search mode.

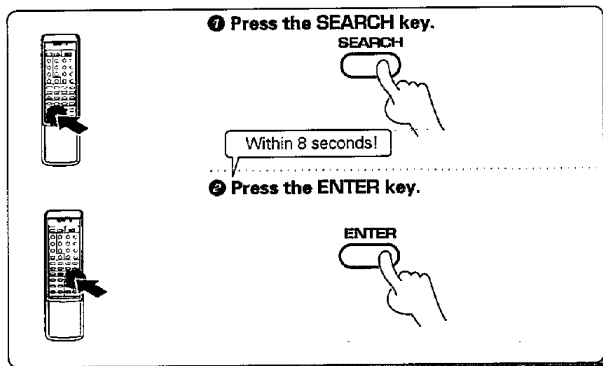

- The disc name file on side A of the disc with the lowest disc number among the registered discs is displayed first. In a second later, the disc names on sides A and B start to be displayed alternately at 1-second intervals.

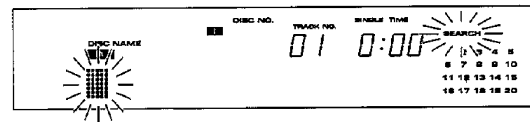

- To end the search mode, press the **SEARCH** key in the search mode.

2 Select the disc name file of the desired disc.

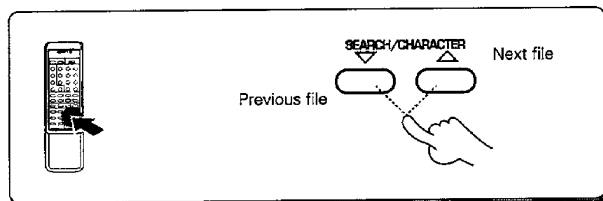

- Press repeatedly until the desired disc name is displayed.
- The disc name on disc name file side A of the next (previous) registered disc is displayed first. In a second later, the disc names on sides A and B start to be displayed alternately.

3 Play the disc.

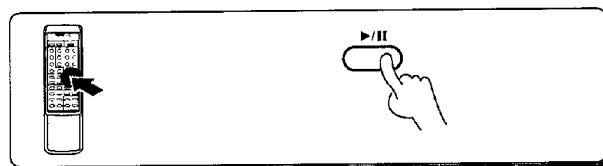

- If the **ENTER** key is pressed in place of the play/pause key, the disc is simply selected.

To switch between file sides A and B

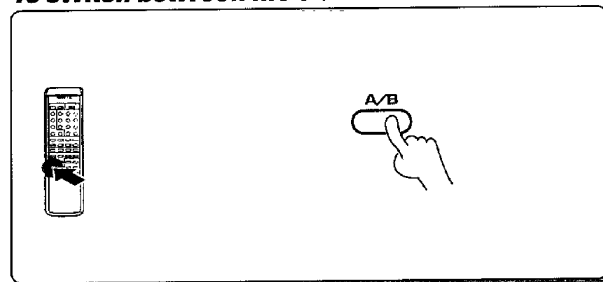

- Each press displays the disc name on file side A or B alternately.

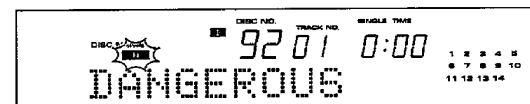
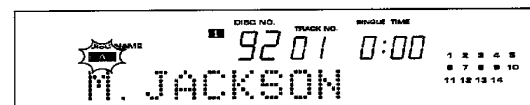



Recalling disc name files

Use the following procedure to search disc names by inputting the initial character of the disc name on disc name file side A.

Preparation

- Load discs in the racks.
- Register disc names.
- Check that the "PGM" indicator is not lit.
- Set the CD player to stop mode.

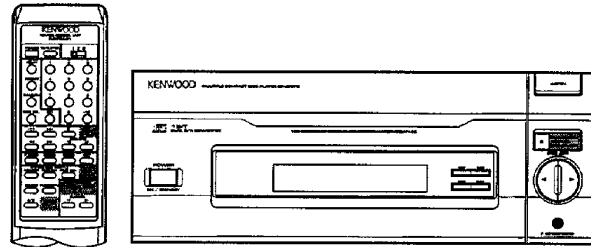

 : Indicates the keys, etc., to be used.

1 Activate the search mode.



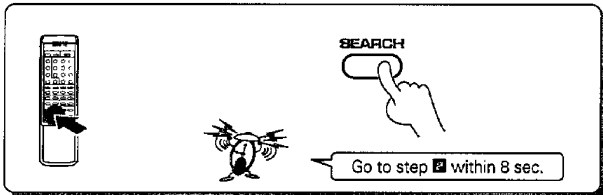
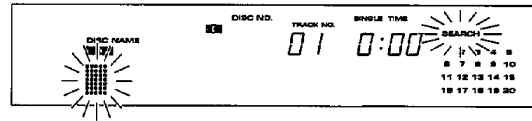

2 Input the initial character of the disc name on disc name file side A.

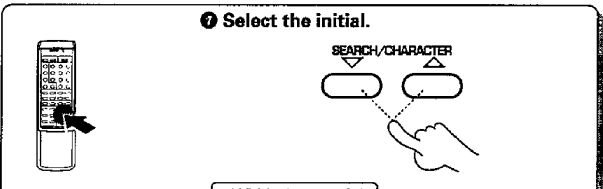
① Select the initial.

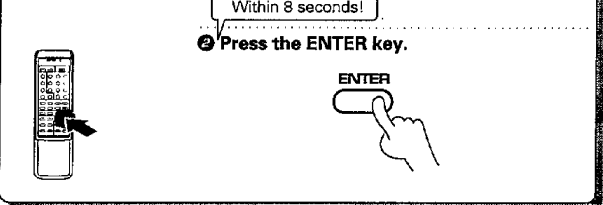

② Press the ENTER key.



• Input the initial character.

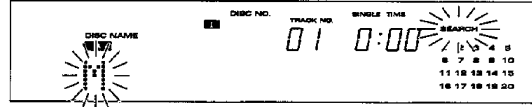

• The disc name on file name side A of the smallest disc number among the side A disc names starting with the input initial character is displayed. In a second later, the disc names on sides A and B start to be displayed alternately.



• It is not possible to search disc names using the initial character of the disc name on file side B.

3 Select the disc name file of the desired disc.

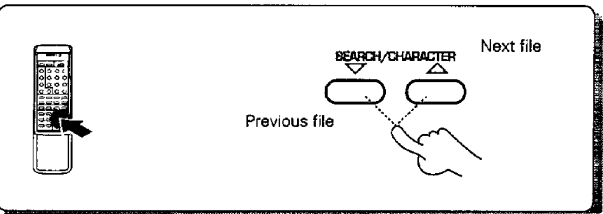

4 Play the disc.

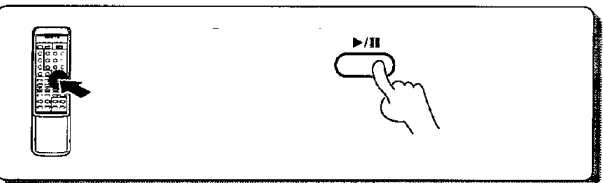

• If the ENTER key is pressed in place of the play/pause key, the disc is simply selected.

• To end the search mode, press the SEARCH key in the search mode.

Registration (deletion) of music type files

DP-J2070 (En)

Use the following procedure to categorize discs according to the music genre and register up to 32 discs in each music type file.

Preparation

- Load discs in the racks.
- Set the CD player to stop mode.
- Check that the "PGM" indicator is not lit.

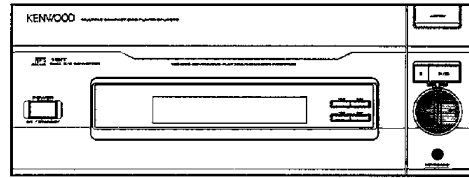
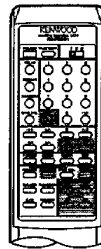

: Indicates the keys, etc., to be used.

1 Activate the music type mode.

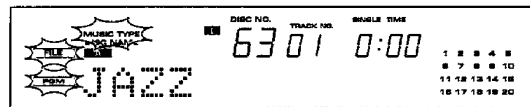
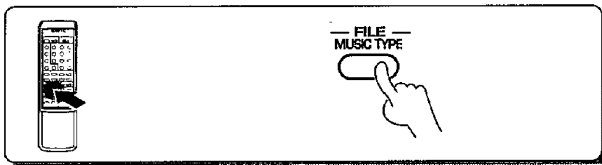

2 Select the music type.

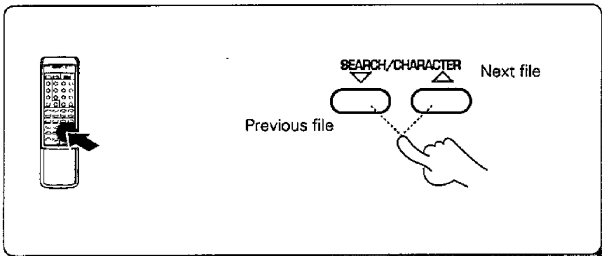

Each press changes the music type file names.

- ① JAZZ
- ② POP
- ③ CLASSIC
- ④ ROCK
- ⑤ RHYTHM&BLUES
- ⑥ COUNTRY
- ⑦ EASY
- ⑧ USER 1
- ⑨ USER 2
- ⑩ USER 3

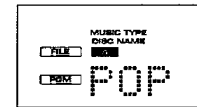

Go to step 3 unless you want to change the name of a user name file.

- If you selects a user name file (USER 1 to 3) and want to change the file name, proceed to steps 3 and 4.

3 Enter the selection in memory (Only when changing the name of a user name file).

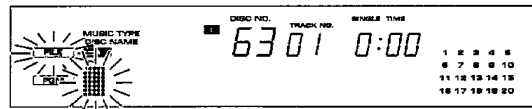
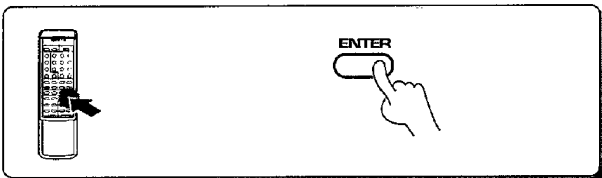

4 Input characters (Only when changing the name of a user name file).

① Input a character.

② Press the ENTER key.

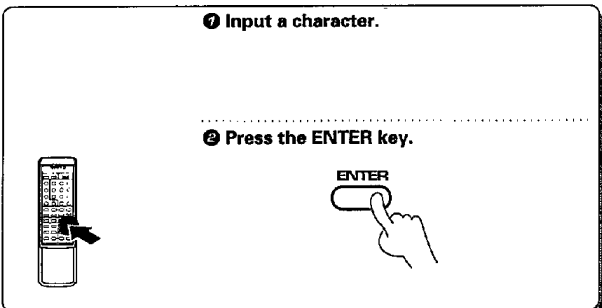

- Refer to ① of "How to input characters". The name of a user name file cannot be input from the PC keyboard. -25-

- Repeat ① and ② to input the name characters of the user name file.



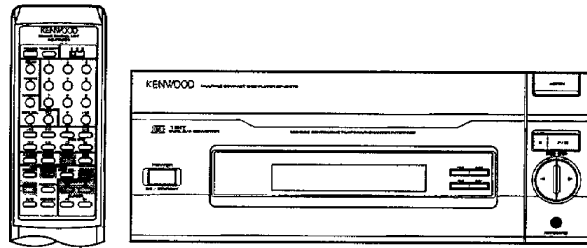

■ : Indicates the keys, etc., to be used.

5 Select discs.

1 Select the disc number.

Previous disc DISC SKIP Next disc

Within 8 seconds!

2 Set the input.

SET

- The disc number can be selected directly by using the **DISC SEL.** and numeric keys in place of the **DISC SKIP** keys.

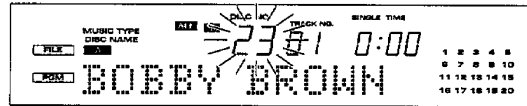

- By repeating **1** and **2**, up to 32 discs can be registered per music type file. "FULL" is displayed when no more disc is acceptable.
- Every time the **CHECK** key is pressed, the disc numbers can be displayed in the order they were registered. When it is required to change a disc, display the disc number to be changed and perform step **1**.
- To register another music type file, repeat the procedure from step **1**.
- To end the music type mode, press the **P.MODE** key while the "MUSIC TYPE" indicator is lit.

To clear registered disc(s)

1 Perform steps 1 and 2 of "Registration (deletion) of music type files" to recall the music type file containing the disc number(s) to be cleared.

2 Press the CLEAR key.

CLEAR

- Each press clears the last disc number in the file.

To reset the name assigned to a user name file

1 Perform steps 1 to 2 of "Registration (deletion) of music type files" to recall the user name file with the name to be reset.

2 Press the DELETE key.

DELETE

3 Press the ENTER key.

ENTER

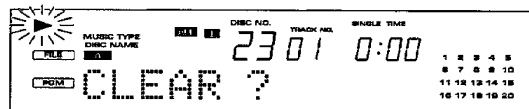

- Press the ■ key while "CLEAR?" is displayed to end the delete mode.

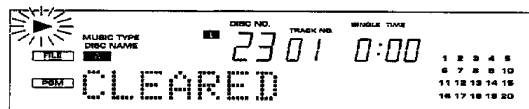

- The assigned user name is cleared and reset to original user name "USER 1 to 3".

Playing a music type file

DP-J2070 (En)

Preparation

- Load discs in the racks.
- Register music type files.
- Check that the 'PGM' indicator is not lit.

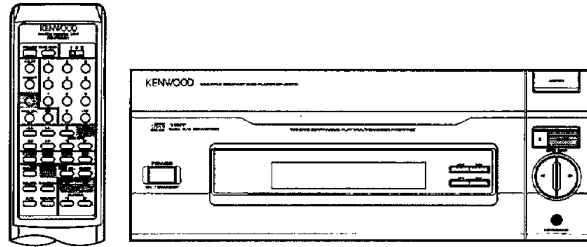

■ : Indicates the keys, etc., to be used.

1 Activate the music type mode.

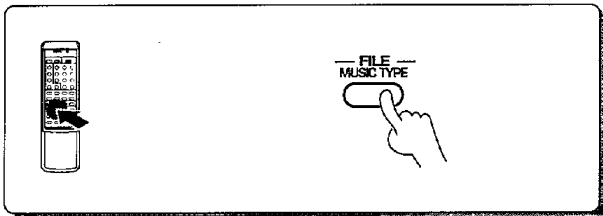

- Only the **SINGLE TIME** displays are available in the music type mode.

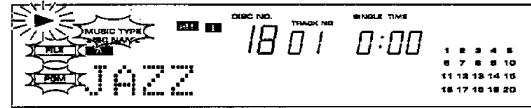

2 Select the music type.

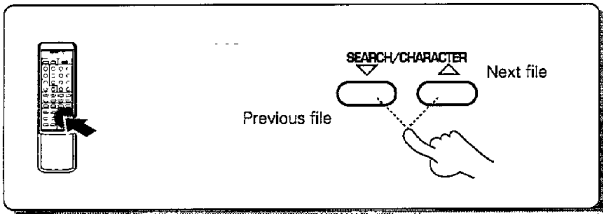

- Press repeatedly until the desired music type is displayed.

Display when music type "CLASSIC" is selected



3 Start playback.

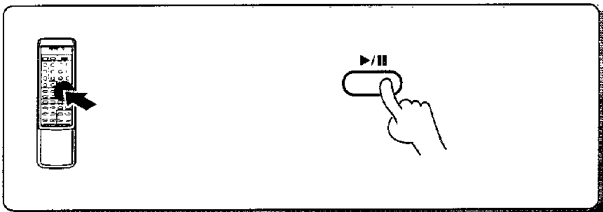

- Discs are played in the order they were registered in the music type file.

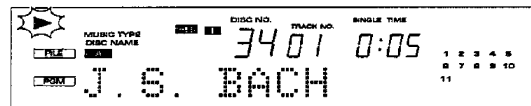

- To end the music type mode, press the **P.MODE** key while the "MUSIC TYPE" indicator is lit.

Random playback within a music type

- 1 Perform steps 1 and 2 of "Playing a music type file".

- 2 Start random playback.

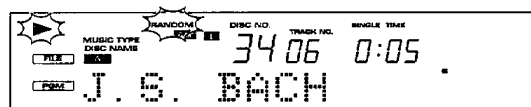
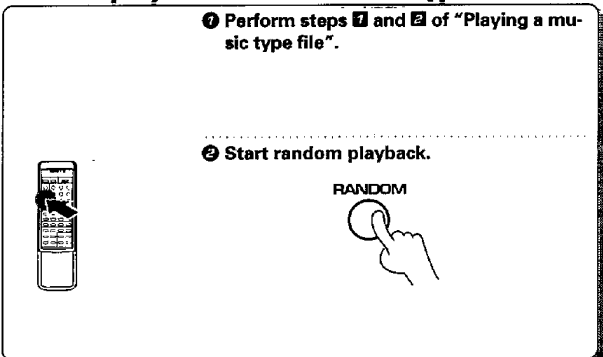

- To end random playback, press the **■** key (which stops the CD player) or the **RANDOM** key (which starts normal playback).

Registration (deletion) of best selection file

DP-J2070 (En)

Use the following procedure to register favorite tracks in the best selection file while playing a CD.

Preparation

- Load discs in the racks.
- Check that the "PGM" indicator is not lit.

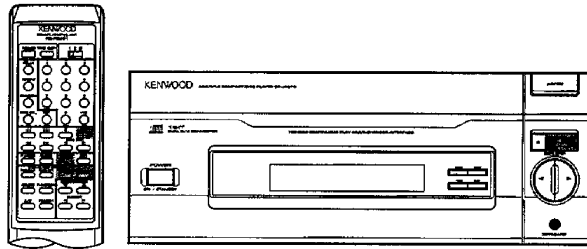

■ : Indicates the keys, etc., to be used.

1 Play the track to be registered.

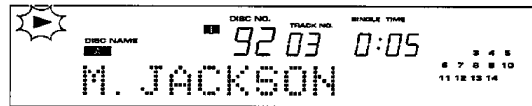
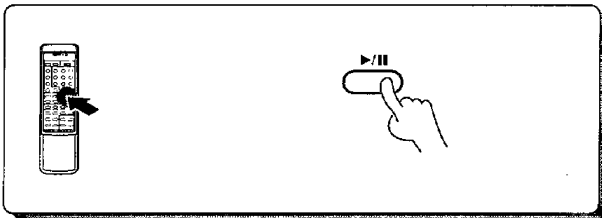

- Only the track being played can be registered.

2 Register it in the best selection file.

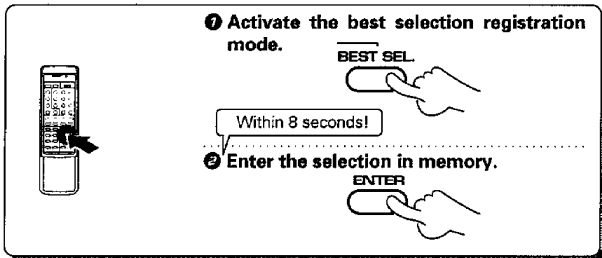

- To end the best selection registration mode (which is indicated by the blinking of the **BEST SELECTION** indicator), press the **BEST SEL.** key again.

3 Register other favorite tracks by performing steps 1 and 2 for each of them.

- Up to 32 tracks can be registered. "FULL" is displayed when no more disc is acceptable.

To clear registered tracks

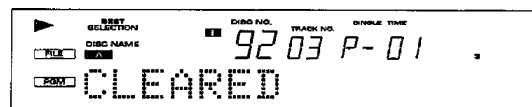
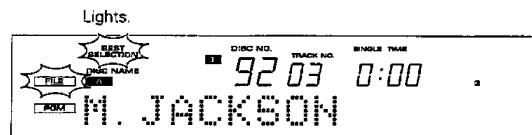
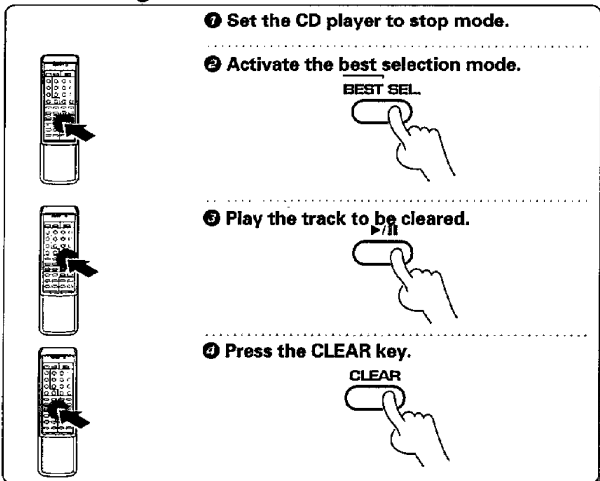

- The track being played is cleared from the best selection file.

Playing the best selection file

DP-J2070 (En)

Preparation

- Load discs in the racks.
- Register tracks in the best selection file.
- Check that the "PGM" indicator is not lit.

- 19
- 31

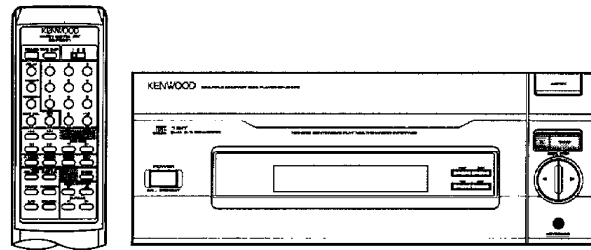

 : Indicates the keys, etc., to be used.

1 Set the CD player to stop mode.

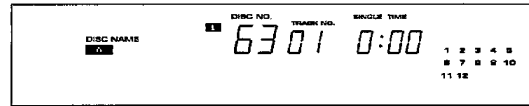
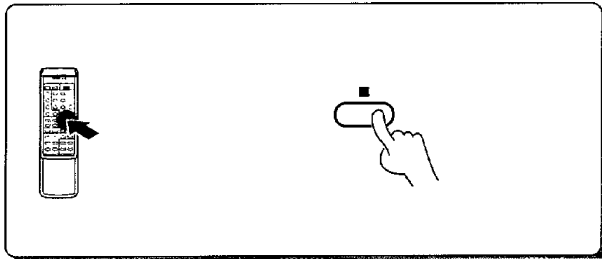

2 Activate the best selection mode.

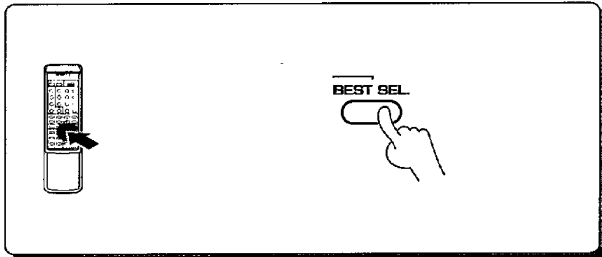

Only the "SINGLE TIME" displays are available in the best selection



mode.

- Every time the **CHECK** key is pressed, the disc numbers and track numbers can be displayed in the order they were registered.
- To end the best selection mode (which is indicated by steady lighting of the **BEST SELECTION** indicator), press the **P.MODE** key.

3 Start playback.

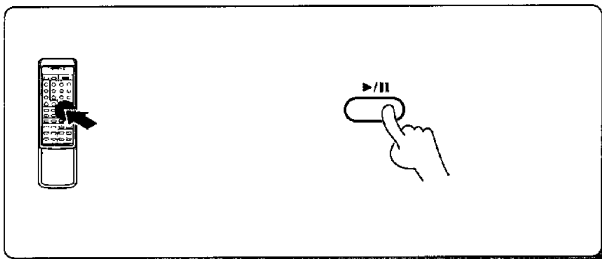

- The tracks are played in the order they were registered.



- Pressing the **BEST SEL.** key during playback activates the best selection registration mode.

Relay playback

DP-J2070 (En)

When this unit is connected with KENWOOD CD player(s) using mini-plug cord(s) (optional), relay playback or relay random playback between more than one CD player is possible. (With connection system B, only relay playback is possible.)

Note that, with this operation, the connection system configuration and operation method is variable depending on the equipment connected.

Possible connection systems and operations

System A

This system configuration is used for connection with KENWOOD CD player(s) equipped with the RELAY CONTROL jacks.

Operation outline

- Relay playback (or relay random playback is possible between sets A, B and C. When the power of set B or C is off (STANDBY mode), relay playback is possible between sets A and C or between sets A and B.
- Even when the power of set A is off (STANDBY mode), the playback of set B or C can be reproduced if the power of set B or C is ON. But relay playback is not possible in this case.

Connections and set-up

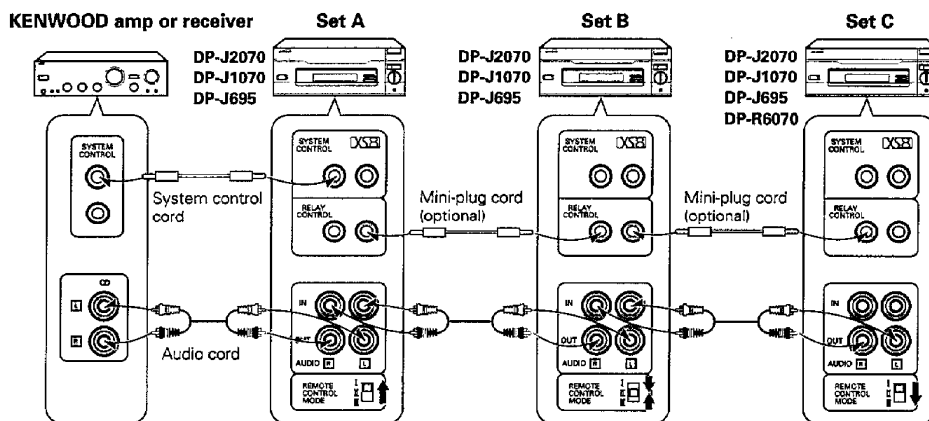

Set-up of REMOTE CONTROL MODE switch

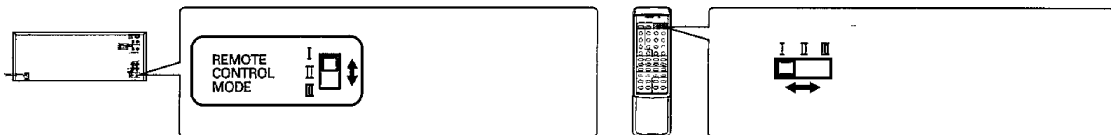

Operating notes

- Before starting playback, set the input selector of the amplifier or receiver to CD.
- With each pair of set and remote control unit, set the remote control mode switches on the rear panel and remote control unit to the same positions according to the system configuration. If each pair of switches are not in the same position, relay playback and remote control operations will not be possible.



1. The remote control unit provided with the KENWOOD amplifier or receiver can control set A only.
2. If more than one set is played simultaneously, the playback sounds of all sets will be reproduced together; do not play more than one set simultaneously.
3. If the power of set A is turned off during playback of set B or C, the set being played stops playback.
4. The DP-R6070 can be remote controlled using the remote control unit provided with this unit. In this case, set the remote control mode switch of the remote control unit to the same position as the REMOTE CONTROL MODE switch on the rear panel of the DP-R6070.

System B

This system configuration is used for connection with any KENWOOD CD player.

Operation outline

- After all discs in set B have been played, the all discs in set A are played and then relay playback stops. Relay random playback is not possible with this system.
- Even when the power of set A is off (STANDBY mode), the playback of set B can be reproduced if the power of set B is ON.

Connections and set-up

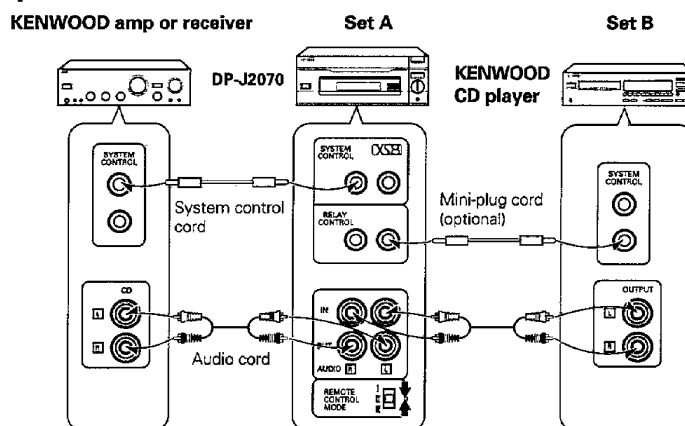

Set-up of REMOTE CONTROL MODE switch

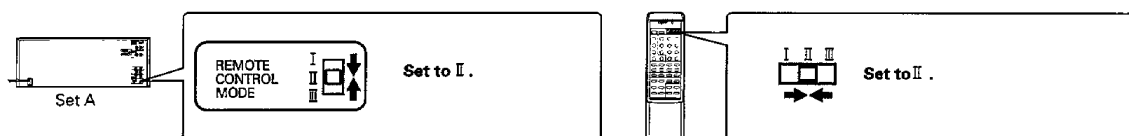

Operating notes

- Set the **REMOTE CONTROL MODE** switch of set A to II.
- Connect the mini-plug cord (optional) to the **SYSTEM CONTROL** jack (XS or XS2) of set B.
- Be always sure to switch the power of set A first, then B. If the powers are switched on in the reverse order, relay playback will not be possible.
- Before starting playback, set the input selector of the amplifier or receiver to **CD**.
- With each pair of set and remote control unit, set the remote control mode switches on the rear panel and remote control unit to the same positions according to the system configuration. If each pair of switches are not in the same position, relay playback and remote control operations will not be possible.



1. The remote control unit provided with the KENWOOD amplifier or receiver can control set B only.
2. If two sets are played simultaneously, the playback sounds of them will be reproduced together; do not play two sets simultaneously.
3. If the power of set A is turned off during playback of set B, set B stops playback.

Preparation

- Connect equipment according to "Possible connection systems and operations".
- Switch ON the powers of the connected equipment.
- Load discs in the racks or tray of the connected CD players.
- Check that the 'PGM' indicator is not lit.
- Set the CD players in stop mode.

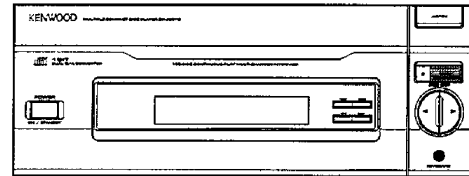
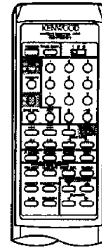

■ : Indicates the keys, etc., to be used.

Relay playback

Discs loaded in the CD player sets connected through mini-plug cord(s) (optional) can be played set by set.

① Activate the relay play mode.

② Start playback.

With system A

With system B

Press the play key of another CD player (set B).



- Each of the connected sets plays discs from the currently displayed disc number to the last disc number. When the last disc number has been played, the next set starts playback.
- With system A, sets are played in order of their REMOTE CONTROL MODE switch positions I, II, III.
- With system B, set B is played first then set A is played.
- Playback stops after all sets have completed playback.
- Press the **RELAY** key again to end the relay play mode.

Relay random playback (System A only)

Between CD players connected through mini-plug cord(s) (optional), relay playback can be repeated starting with set A by randomly selecting only one track at a time from each set.

① Activate the relay play mode.

② Start random playback.

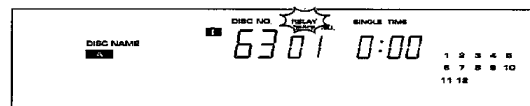

Display during random playback of set A

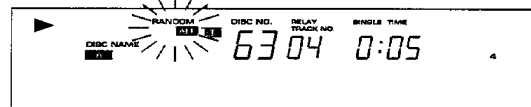

- When the **RELAY** key is pressed during relay random playback, the relay random mode is ended and the set being played stops playback.
- When the **RANDOM** key is pressed during relay random playback, only the random mode is ended and the set being played stops playback.



◀ and ▶ keys are invalid during relay playback or relay random playback.

Timer operation

DP-J2070 (En)

As this unit incorporate the timer standby function, playback can be started at desired moment if a commercially available audio timer is combined with this unit.

Preparation



- Load discs in the racks.
- Connect the system components so that their power can be switched on by the timer.
- Read the instruction manual of the timer carefully.

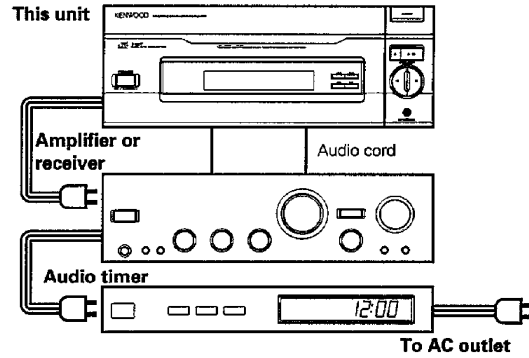

1 Set the power switches of the system components to the ON positions.

2 Select the disc to be played.

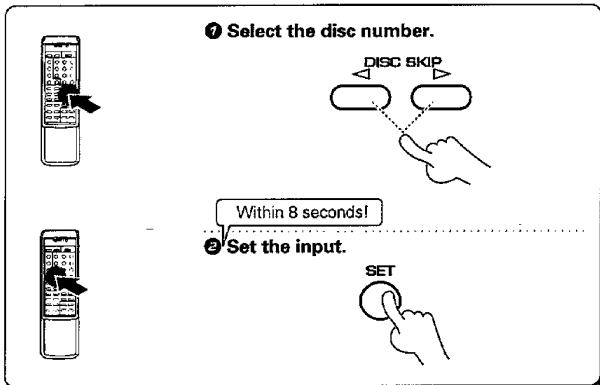

3 Set the listening volume.

- ① Play the disc.
- ② Adjust the volume on the amplifier or receiver.
- ③ Stop playback.

4 Set the timer for the desired ON time.

- The disc number can be selected directly by using the **DISC SEL.** and numeric keys in place of the **DISC SKIP** keys.

- If it is required to start programmed playback with timer, program tracks now. -18-

- Read the instruction manual of the timer carefully.
- When the set time comes, playback will start automatically.

Disc handling precautions

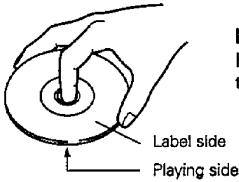

Handling

Hold compact discs so that you do not touch the playing surface.



Do not attach paper or tape to either the playing side or the label side of compact discs.

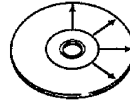

Cleaning

If fingerprints or foreign matter become attached to the disc, lightly wipe the disc with a soft cotton cloth (or similar) from the center of the disc outwards in a radial manner.

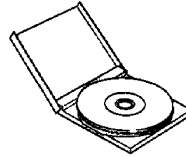

Storage

When a disc is not to be played for a long period of time, remove it from the CD player and store it in its case.

Caution on disc used

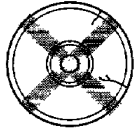

Never play cracked or warped disc.

During playback, the disc rotates at high speed in the player. Therefore, to avoid danger, never use a cracked or deformed disc or a disc repaired with tape or adhesive agent.

Note related to transportation and movement (CD player)

Before transporting or moving this unit, carry out the following operation.

1. With the door panel closed, set the POWER switch to OFF.
2. Wait a few seconds, then disconnect the power plug.
3. Take out all discs from the racks and close the door panel.
4. Turn the unit upside down and attach the transport screws.



Periodic inspection

This unit incorporates an optical pickup which is a precision device. It is recommended to have this unit inspected periodically to clear the pickup after about 1000 hours of use, although this period may vary depending on the installation condition (temperature, humidity, dust, smoke, etc.) of the unit.

The unit has inspected, please consult your dealer or a KENWOOD service center in your area.

Memory backup function

Stored connects in at least 3 days after power plug is unplugged from the AC outlet.

Power status (ON or OFF),
Program contents,
File registration contents.



Operation to reset

The microcomputer may fall into malfunction (impossibility to operate, erroneous display, etc.) when the power cord is unplugged while power is ON or due to an external factor. In this case, execute the following method to reset the microcomputer and return it to normal condition.





Unplug the power cord from the power socket and, while holding the STOP key depressed, plug the power cord into the socket again.

- Please note that restarting the microcomputer clears the contents stored in it and returns it to the condition when it left the factory.

Remote control unit

| Symptom | Cause | Remedy |
|---|--|--|
| Remote control operation is not possible. | <ul style="list-style-type: none"> • Batteries are exhausted. • The remote control unit is too far away from the main system, controlling angel is too large, or there is an obstacle in between. • The REMOTE CONTROL MODE switches are not set properly. | <ul style="list-style-type: none"> • Replace with new batteries. • Operate the remote control unit within the controllable range.  • Set the REMOTE CONTROL MODE switches properly.   |

CD Player

| Symptom | Cause | Remedy |
|--|--|---|
| No power is applied with the POWER switch ON. | <ul style="list-style-type: none"> • Power plug is loosely connected. • With the power plug connected to the switched AC outlet of an amplifier, the power of the amplifier is turned off. | <ul style="list-style-type: none"> • Insert the power plug firmly to the AC outlet. • Turn the amplifier's power ON. |
| Disc is loaded, player does not play. | <ul style="list-style-type: none"> • Disc is loaded upside down. • Disc is loose. • Disc is dirty. • Disc is cracked. • Condensation occurred on the optical lens unit. | <ul style="list-style-type: none"> • Load the disc again with its label side up. • Insert disc properly. • Wipe off the dust on the surface of the disc referring to "Disc handling precautions".  • Replace the disc with a new one. • Leave the player for about 1 hour so that the condensation is removed.  |
| No sound. | <ul style="list-style-type: none"> • Disc is not loaded. • Play mode is not entered (The play/pause indicator is not lit). • Disc is too dirty. • Disc is cracked. • The connection cords are inserted loosely. | <ul style="list-style-type: none"> • Load a disc and press the ►/ key. • Press the ►/ key. • Wipe off the dust on the disc surface referring to "Disc handling precautions".  • Replace the disc with a new one. • Connect all connection cords firmly. |
| Music is interrupted. (Sound is skipped.) | <ul style="list-style-type: none"> • Disc is too dirty. • Disc is cracked. • Oscillation is applied to this unit. | <ul style="list-style-type: none"> • Wipe off the dust on the disc surface referring to "Disc handling precautions".  • Replace the disc with a new one. • Try selecting a place where no strong vibrations occur by changing the installation place, etc. |
| Disc begins to play when power is switched ON. | <ul style="list-style-type: none"> • The CD player will automatically play when a disc has been inserted and power is switched ON. | <ul style="list-style-type: none"> • To avoid disc playing automatically, remove disc before switching off power. |



Do not use contact cleaners because it could cause a malfunction. Be specially careful against contact cleaners containing oil, for they may deform the plastic components.

KENWOOD

